



S2P EDUTECH

From Student To Professional

CERTIFICATE

This Certificate is awarded to

Mr./Ms./Mrs. Chetan Porate

S/o/D/O, W/O.

Passed successfully completion of JEST FRAMEWORK course.

During 20/08/22 to 10/09/22 from our authorised Learning centre.

Raxi Nagar, Nagpur.

10/09/22
Date of Issue



Director Signatory

S2P Edutech, 39, Bajirabhu Nagar, Behind South Indian Temple, LIT Road, Nagpur- 440010.

CERTIFICATE OF APPRECIATION

This Certificate is Proudly Presented to

MONALI RAUT

*In recognition of his/her working as an intern using
JEST Framework for the project titled EMERGE
during 20/08/2022 to 10/09/2022*



A handwritten signature in black ink, appearing to read 'S. Malani'.

Director Signatory

S. Malani

Director Signatory

The logo for vroomble, with the word 'vroomble' in a lowercase, sans-serif font.

**S.B. JAIN INSTITUTE OF TECHNOLOGY, MANAGEMENT
& RESEARCH, NAGPUR.**

(An Autonomous Institute, Affiliated to RTMNU, Nagpur)



**CERTIFICATE OF COMPLETION
PRACTICE SCHOOL - II**

This is to certify that

Abdul Quadeer

of fifth semester in Computer Science and Engineering Department, has completed
3 weeks (21 days) internship, organized from **20/08/2022** to **09/09/2022** for Practice School-II, in

Salesforce (Admin)

under the guidance of

Mr. Ramanand Samdekar, Tavant Technology, Hyderabad

It has been found that the work accomplished is satisfactory and approved for submission.

Mrs. Sonam Chopade
Internal Mentor

Mrs. Gulrukh Nazneen
Internship Incharge

Dr. Animesh Tayal
Head of Department

**S.B. JAIN INSTITUTE OF TECHNOLOGY, MANAGEMENT
& RESEARCH, NAGPUR.**

(An Autonomous Institute, Affiliated to RTMNU, Nagpur)



**CERTIFICATE OF COMPLETION
PRACTICE SCHOOL - II**

This is to certify that
Shivam Mohan Thakur

of fifth semester in Computer Science and Engineering Department, has completed
3 weeks (21 days) internship, organized from **20/08/2022** to **09/09/2022** for Practice School-II, in

Machine Learning and Data Science

under the guidance of

Mr. Nisarg Gandhewar, Amdocs Telecommunications, Pune

It has been found that the work accomplished is satisfactory and approved for submission.

Mr. Nisarg Gandhewar
External Mentor

Mrs. Gulrukh Nazneen
Internship Incharge

Dr. Animesh Tayal
Head of Department



CERTIFICATE

OF INTERNSHIP

This certificate is proudly awarded to

Bhavarth G. Patel

in recognition of his/her efforts and achievement in completing the
Four Weeks *internship program in* **Data Visualization using Advance Excel**
conducted From **10th July -05th Aug 2023**

A handwritten signature in black ink, appearing to be 'B. G. Patel', is written above a horizontal line.

DIRECTOR

**S.B. JAIN INSTITUTE OF TECHNOLOGY, MANAGEMENT
& RESEARCH, NAGPUR.**

(An Autonomous Institute, Affiliated to RTMNU, Nagpur)



CERTIFICATE OF COMPLETION
PRACTICE SCHOOL - II

This is to certify that

Sakshi Parate

of fifth semester in Computer Science and Engineering Department, has completed
3 weeks (21 days) internship, organized from **20/08/2022** to **09/09/2022** for Practice School-II, in

Web Development & IoT

under the guidance of

Mr. Ashish Labade, Tech Vegan, Nagpur

It has been found that the work accomplished is satisfactory and approved for submission.

Mr. Ashish Labade
Internal/External Mentor

Mrs. Gulrukh Nazneen
Internship Incharge

Dr. Animesh Tayal
Head of Department

**S.B. JAIN INSTITUTE OF TECHNOLOGY, MANAGEMENT
& RESEARCH, NAGPUR.**

(An Autonomous Institute, Affiliated to RTMNU, Nagpur)



**CERTIFICATE OF COMPLETION
PRACTICE SCHOOL - II**

This is to certify that
Sourabh Saroj Mistry

of fifth semester in Computer Science and Engineering Department, has completed
3 weeks (21 days) internship, organized from **20/08/2022** to **09/09/2022** for Practice School-II, in

Machine Learning and Data Science

under the guidance of

Dr. Amruta Chimote, ITVedant, Mumbai

It has been found that the work accomplished is satisfactory and approved for submission.

Dr. Amruta Chimote
External Mentor

Mrs. Gulrukh Nazneen
Internship Incharge

Dr. Animesh Tayal
Head of Department

**S.B. JAIN INSTITUTE OF TECHNOLOGY, MANAGEMENT
& RESEARCH, NAGPUR.**

(An Autonomous Institute, Affiliated to RTMNU, Nagpur)



**CERTIFICATE OF COMPLETION
PRACTICE SCHOOL - II**

This is to certify that

Mohd Tahzeeb Khan

of fifth semester in Computer Science and Engineering Department, has completed
3 weeks (21 days) internship, organized from **20/08/2022** to **09/09/2022** for Practice School-II, in

Software Testing

under the guidance of

Mr. Gati Krishna Meher, MKP IT Services, Nagpur

It has been found that the work accomplished is satisfactory and approved for submission.

Mr. Gati Krishna Meher
External Mentor

Mrs. Gulrukh Nazneen
Internship Incharge

Dr. Animesh Tayal
Head of Department

CERTIFICATE OF APPRECIATION

This Certificate is Proudly Presented to

ACHAL JICHKAR

*In recognition of his/her working as an intern using
JEST Framework for the project titled EMERGE
during 20/08/2022 to 10/09/2022*



[Signature]
Director Signatory

S. Malani
Director Signatory

vroomble



S2P EDUTECH

From Student To Professional

CERTIFICATE

This Certificate is awarded to

Mr./Ms./Mrs. Jahil Ichanke

S/o/D/O,W/O.

Passed successfully completion of JEST FRAMEWORK course,

During 20/08/22 to 10/09/22 from our authorised Learning centre.....

..... Karri Nagar, Nagpur

10/09/22

Date of Issue

Epikawthon

Director Signatory

S2P Edutech, 39, Bajjprabhu Nagar, Behind South Indian Temple, LIT Road, Nagpur- 440010,

**S.B. JAIN INSTITUTE OF TECHNOLOGY, MANAGEMENT
& RESEARCH, NAGPUR.**

(An Autonomous Institute, Affiliated to RTMNU, Nagpur)



**CERTIFICATE OF COMPLETION
PRACTICE SCHOOL - II**

This is to certify that

Avantika Avinash Raut

of fifth semester in Computer Science and Engineering Department, has completed
3 weeks (21 days) internship, organized from **20/08/2022** to **09/09/2022** for Practice School-II, in

JavaScript and Angular JS

under the guidance of

Ms. Ashvini Tarar, Assistant Professor, SBJITMR, Nagpur

It has been found that the work accomplished is satisfactory and approved for submission.

Ms. Ashvini Tarar
Internal Mentor

Mrs. Gulrukh Nazneen
Internship Incharge

Dr. Animesh Tayal
Head of Department

**S.B. JAIN INSTITUTE OF TECHNOLOGY, MANAGEMENT
& RESEARCH, NAGPUR.**

(An Autonomous Institute, Affiliated to RTMNU, Nagpur)



**CERTIFICATE OF COMPLETION
PRACTICE SCHOOL - II**

This is to certify that

Utkarsh Gopal Shahare

of fifth semester in Computer Science and Engineering Department, has completed
3 weeks (21 days) internship, organized from 20/08/2022 to 09/09/2022 for Practice School-II, in

Web Development & IoT

under the guidance of

Mr. Ashish Labade, Tech Vegan, Nagpur

It has been found that the work accomplished is satisfactory and approved for submission.

Mr. Ashish Labade
Internal/External Mentor

Mrs. Gulrukh Nazreen
Internship Incharge

Dr. Animesh Tayal
Head of Department

**S.B. JAIN INSTITUTE OF TECHNOLOGY, MANAGEMENT
& RESEARCH, NAGPUR.**

(An Autonomous Institute, Affiliated to RTMNU, Nagpur)



**CERTIFICATE OF COMPLETION
PRACTICE SCHOOL - II**

This is to certify that
Pranay Sanjay Tiwaskar

of fifth semester in Computer Science and Engineering Department, has completed
3 weeks (21 days) internship, organized from **20/08/2022** to **09/09/2022** for Practice School-II, in

Software Testing

under the guidance of

Mr. Gati Krishna Meher, MKP IT Services, Nagpur

It has been found that the work accomplished is satisfactory and approved for submission.

Mr. Gati Krishna Meher
External Mentor

Mrs. Gulrukh Nazneen
Internship Incharge

Dr. Animesh Tayal
Head of Department



S2P EDUTECH

From Student To Professional

CERTIFICATE

This Certificate is awarded to

Mr./Ms./Mrs. Goyal Dhakate

S/o/D/O,W/O.

Passed successfully completion of JEST FRAMEWORK course,

During 20/08/22 to 10/09/22 from our authorised Learning centre.....

Ravi Nagar, Nagpur

10/09/22
Date of Issue



Chavhan
Director Signatory

S2P Edutech, 39, Bajiprabhu Nagar, Behind South Indian Temple, LIT Road, Nagpur- 440010,

**S.B. JAIN INSTITUTE OF TECHNOLOGY, MANAGEMENT
& RESEARCH, NAGPUR.**

(An Autonomous Institute, Affiliated to RTMNU, Nagpur)



**CERTIFICATE OF COMPLETION
PRACTICE SCHOOL - II**

This is to certify that

Ekata Dnyaneshwar Chimote

of fifth semester in Computer Science and Engineering Department, has completed
3 weeks (21 days) internship, organized from **20/08/2022** to **09/09/2022** for Practice School-II, in

Software Testing

under the guidance of

Mr. Gati Krishna Meher, MKP IT Services, Nagpur

It has been found that the work accomplished is satisfactory and approved for submission.

Mr. Gati Krishna Meher
External Mentor

Mrs. Gulrukh Nazneen
Internship Incharge

Dr. Animesh Tayal
Head of Department

CERTIFICATE OF APPRECIATION

This Certificate is Proudly Presented to

HANSIKA THAKARE

*In recognition of his/her working as an intern using
JEST Framework for the project titled EMERGE
during 20/08/2022 to 10/09/2022*



[Signature]
Director Signatory

S. Malani
Director Signatory

vroomble



S2P EDUTECH

From Student To Professional

CERTIFICATE

This Certificate is awarded to

Mr./Ms./Mrs. Isha shah

S/o/D/O,W/O.

Passed successfully completion of JEST FRAMEWORK course,

During 20/08/22 to 10/09/22 from our authorised Learning centre.....

Ravi Nagar, Nagpur.

10/09/22
Date of Issue

Director Signatory

S2P Edutech, 39, Bajprabhu Nagar, Behind South Indian Temple, LIT Road, Nagpur- 440010.



S2P EDUTECH

From Student To Professional

CERTIFICATE

This Certificate is awarded to

Mr./Ms./Mrs. Om Kanhe

S/o/D/O,W/O

Passed successfully completion of JEST FRAMEWORK course,

During 20/08/22 to 10/09/22 from our authorised Learning centre

Ravi Nagar, Nagpur

10/09/22

Date of issue

Rajendra Prasad
Director Signatory

S2P Edutech, 39, Bajprabhu Nagar, Behind South Indian Temple, LIT Road, Nagpur- 440010.

**S.B. JAIN INSTITUTE OF TECHNOLOGY, MANAGEMENT
& RESEARCH, NAGPUR.**

(An Autonomous Institute, Affiliated to RTMNU, Nagpur)



**CERTIFICATE OF COMPLETION
PRACTICE SCHOOL - II**

This is to certify that

Mohd Raziullah Khatib

of fifth semester in Computer Science and Engineering Department, has completed
3 weeks (21 days) internship, organized from 20/08/2022 to 09/09/2022 for Practice School-II, in

Software Testing

under the guidance of

Mr. Gati Krishna Meher, MKP IT Services, Nagpur

It has been found that the work accomplished is satisfactory and approved for submission.

Mr. Gati Krishna Meher
External Mentor

Mrs. Gulrukh Nazneen
Internship Incharge

Dr. Animesh Tayal
Head of Department

**S.B. JAIN INSTITUTE OF TECHNOLOGY, MANAGEMENT
& RESEARCH, NAGPUR.**

(An Autonomous Institute, Affiliated to RTMNU, Nagpur)



**CERTIFICATE OF COMPLETION
PRACTICE SCHOOL - II**

This is to certify that

Kanak Budhlani

of fifth semester in Computer Science and Engineering Department, has completed
3 weeks (21 days) internship, organized from **20/08/2022** to **09/09/2022** for Practice School-II, in

Machine Learning and Data Science

under the guidance of

Mr. Nisarg Gandhewar, Amdocs Telecommunications, Pune

It has been found that the work accomplished is satisfactory and approved for submission.

Mr. Nisarg Gandhewar
External Mentor

Mrs. Gulrukh Nazneen
Internship Incharge

Dr. Animesh Tayal
Head of Department



Internship Certificate

23 September 2022

This is to certify that **Aman Kundal** has successfully completed the internship as a **React.js** from 20 August 2022 to 20 September 2022.

Aman Kundal interned under the guidance of Aniket Vairagade. The performance was found to be satisfactory.

We wish **Aman Kundal** all the best for all future endeavors.

A handwritten signature in black ink, appearing to read "Aniket Vairagade", is written over a horizontal line.

**Uphill Technologies
Pvt. Ltd.**

**S.B. JAIN INSTITUTE OF TECHNOLOGY, MANAGEMENT
& RESEARCH, NAGPUR.**

(An Autonomous Institute, Affiliated to RTMNU, Nagpur)



**CERTIFICATE OF COMPLETION
PRACTICE SCHOOL - II**

This is to certify that

Komal Sunil Sakhare

of fifth semester in Computer Science and Engineering Department, has completed
3 weeks (21 days) internship, organized from **20/08/2022** to **09/09/2022** for Practice School-II, in

Machine Learning and Data Science

under the guidance of

Dr. Amruta Chimote, ITVedant, Mumbai

It has been found that the work accomplished is satisfactory and approved for submission.

Dr. Amruta Chimote
External Mentor

Mrs. Gulrukh Nazneen
Internship Incharge

Dr. Animesh Tayal
Head of Department

**S.B. JAIN INSTITUTE OF TECHNOLOGY, MANAGEMENT
& RESEARCH, NAGPUR.**

(An Autonomous Institute, Affiliated to RTMNU, Nagpur)



**CERTIFICATE OF COMPLETION
PRACTICE SCHOOL - II**

This is to certify that

Mansi Shailesh Yedke

of fifth semester in Computer Science and Engineering Department, has completed
3 weeks (21 days) internship, organized from **20/08/2022** to **09/09/2022** for Practice School-II, in

Machine Learning and Data Science

under the guidance of

Dr. Amruta Chimote, ITVedant, Mumbai

It has been found that the work accomplished is satisfactory and approved for submission.

Dr. Amruta Chimote
External Mentor

Mrs. Gulrukh Nazreen
Internship Incharge

Dr. Animesh Tayal
Head of Department

**S.B. JAIN INSTITUTE OF TECHNOLOGY, MANAGEMENT
& RESEARCH, NAGPUR.**

(An Autonomous Institute, Affiliated to RTMNU, Nagpur)



**CERTIFICATE OF COMPLETION
PRACTICE SCHOOL - II**

This is to certify that

Nikita Ravindra Waghade

of fifth semester in Computer Science and Engineering Department, has completed
3 weeks (21 days) internship, organized from **20/08/2022** to **09/09/2022** for Practice School-II, in

Machine Learning and Data Science

under the guidance of

Dr. Amruta Chimote, ITVedant, Mumbai

It has been found that the work accomplished is satisfactory and approved for submission.

Dr. Amruta Chimote
External Mentor

Mrs. Gulrukh Nazneen
Internship Incharge

Dr. Animesh Tayal
Head of Department

**S.B. JAIN INSTITUTE OF TECHNOLOGY, MANAGEMENT
& RESEARCH, NAGPUR.**

(An Autonomous Institute, Affiliated to RTMNU, Nagpur)



**CERTIFICATE OF COMPLETION
PRACTICE SCHOOL - II**

This is to certify that

Ayaan Khan

of fifth semester in Computer Science and Engineering Department, has completed
3 weeks (21 days) internship, organized from **20/08/2022** to **09/09/2022** for Practice School-II, in

Salesforce (Admin)

under the guidance of

Mr. Ramanand Samdekar, Tavant Technology, Hyderabad

It has been found that the work accomplished is satisfactory and approved for submission.

Mrs. Sonam Chopade
Internal Mentor

Mrs. Gulraah Nazreen
Internship Incharge

Dr. Animesh Tayal
Head of Department

**S.B. JAIN INSTITUTE OF TECHNOLOGY, MANAGEMENT
& RESEARCH, NAGPUR.**

(An Autonomous Institute, Affiliated to RTMNU, Nagpur)



**CERTIFICATE OF COMPLETION
PRACTICE SCHOOL - II**

This is to certify that

Swaswati Ghosh

of fifth semester in Computer Science and Engineering Department, has completed
3 weeks (21 days) internship, organized from **20/08/2022** to **09/09/2022** for Practice School-II, in

JavaScript and Angular JS

under the guidance of

Ms. Ashvini Tarar, Assistant Professor, SBJITMR, Nagpur

It has been found that the work accomplished is satisfactory and approved for submission.

Ms. Ashvini Tarar
Internal Mentor

Mrs. Gulrukh Nazneen
Internship Incharge

Dr. Animesh Tayal
Head of Department

**S.B. JAIN INSTITUTE OF TECHNOLOGY, MANAGEMENT
& RESEARCH, NAGPUR.**

(An Autonomous Institute, Affiliated to RTMNU, Nagpur)



**CERTIFICATE OF COMPLETION
PRACTICE SCHOOL - II**

This is to certify that
Vaibhav Jaydeo Bele

of fifth semester in Computer Science and Engineering Department, has completed
3 weeks (21 days) internship, organized from **20/08/2022** to **09/09/2022** for Practice School-II, in

JavaScript and Angular JS

under the guidance of

Ms. Ashvini Tarar, Assistant Professor, SBJITMR, Nagpur

It has been found that the work accomplished is satisfactory and approved for submission.

Ms. Ashvini Tarar
Internal Mentor

Mrs. Gulrukh Nazneen
Internship Incharge

Dr. Animesh Tayal
Head of Department

**S.B. JAIN INSTITUTE OF TECHNOLOGY, MANAGEMENT
& RESEARCH, NAGPUR.**

(An Autonomous Institute, Affiliated to RTMNU, Nagpur)



**CERTIFICATE OF COMPLETION
PRACTICE SCHOOL - II**

This is to certify that

Khushal Dhok

of fifth semester in Computer Science and Engineering Department, has completed
3 weeks (21 days) internship, organized from **20/08/2022** to **09/09/2022** for Practice School-II, in

JavaScript and Angular JS

under the guidance of

Ms. Ashvini Tarar, Assistant Professor, SBJITMR, Nagpur

It has been found that the work accomplished is satisfactory and approved for submission.

Ms. Ashvini Tarar
Internal Mentor

Mrs. Gulrukh Nazreen
Internship Incharge

Dr. Animesh Tayal
Head of Department

CERTIFICATE OF APPRECIATION

This Certificate is Proudly Presented to

SHREYAS DANKHADE

*In recognition of his/her working as an intern using
JEST Framework for the project titled EMERGE
during 20/08/2022 to 10/09/2022*



[Signature]
Director Signatory

S. Malani
Director Signatory

vfoomble



S2P EDUTECH

From Student To Professional

CERTIFICATE

This Certificate is awarded to

Mr./Ms./Mrs. Faruk shiekh

S/o/D/O,W/O.

Passed successfully completion of JEST FRAMEWORK course,

During 20/08/22 to 10/09/22 from our authorised Learning centre.....

Ravi Nagar, Nagpur.

10/09/22

Date of issue



Director Signatory

S2P Edutech, 39, Bajiprabhu Nagar, Behind South Indian Temple, LIT Road, Nagpur- 440010,

**S.B. JAIN INSTITUTE OF TECHNOLOGY, MANAGEMENT
& RESEARCH, NAGPUR.**

(An Autonomous Institute, Affiliated to RTMNU, Nagpur)



**CERTIFICATE OF COMPLETION
PRACTICE SCHOOL - II**

This is to certify that

Sagar Kumbhalkar

of fifth semester in Computer Science and Engineering Department, has completed
3 weeks (21 days) internship, organized from **20/08/2022** to **09/09/2022** for Practice School-II, in

Machine Learning and Data Science

under the guidance of

Dr. Amruta Chimote, ITVedant, Mumbai

It has been found that the work accomplished is satisfactory and approved for submission.

Dr. Amruta Chimote
External Mentor

Mrs. Gulrukh Nazneen
Internship Incharge

Dr. Animesh Tayal
Head of Department

**S.B. JAIN INSTITUTE OF TECHNOLOGY, MANAGEMENT
& RESEARCH, NAGPUR.**

(An Autonomous Institute, Affiliated to RTMNU, Nagpur)



**CERTIFICATE OF COMPLETION
PRACTICE SCHOOL - II**

This is to certify that

Sanskriti Muley

of fifth semester in Computer Science and Engineering Department, has completed
3 weeks (21 days) internship, organized from **20/08/2022** to **09/09/2022** for Practice School-II, in

Web Development & IoT

under the guidance of

Mr. Ashish Labade, Tech Vegan, Nagpur

It has been found that the work accomplished is satisfactory and approved for submission.

Mr. Ashish Labade
Internal/External Mentor

Mrs. Gulrukh Nazneen
Internship Incharge

Dr. Animesh Tayal
Head of Department

**S.B. JAIN INSTITUTE OF TECHNOLOGY, MANAGEMENT
& RESEARCH, NAGPUR.**

(An Autonomous Institute, Affiliated to RTMNU, Nagpur)



**CERTIFICATE OF COMPLETION
PRACTICE SCHOOL - II**

This is to certify that

Ruchita Rangrao Pothhare

of fifth semester in Computer Science and Engineering Department, has completed
3 weeks (21 days) internship, organized from **20/08/2022** to **09/09/2022** for Practice School-II, in

Machine Learning and Data Science

under the guidance of

Mr. Nisarg Gandhewar, Amdocs Telecommunications, Pune

It has been found that the work accomplished is satisfactory and approved for submission.

Mr. Nisarg Gandhewar
External Mentor

Mrs. Gulrukh Nazneen
Internship Incharge

Dr. Animesh Tayal
Head of Department

**S.B. JAIN INSTITUTE OF TECHNOLOGY, MANAGEMENT
& RESEARCH, NAGPUR.**

(An Autonomous Institute, Affiliated to RTMNU, Nagpur)



**CERTIFICATE OF COMPLETION
PRACTICE SCHOOL - II**

This is to certify that

Nidhi Patekar

of fifth semester in Computer Science and Engineering Department, has completed
3 weeks (21 days) internship, organized from **20/08/2022** to **09/09/2022** for Practice School-II, in

Web Development & IoT

under the guidance of

Mr. Ashish Labade, Tech Vegan, Nagpur

It has been found that the work accomplished is satisfactory and approved for submission.

Mr. Ashish Labade
Internal/External Mentor

Mrs. Gulrukh Nazneen
Internship Incharge

Dr. Animesh Tayal
Head of Department



S2P EDUTECH

From Student To Professional

CERTIFICATE

This Certificate is awarded to

Mr./Ms./Mrs. Soham Linge

S/o/D/O/W/O

Passed successfully completion of JEST FRAMEWORK course.

During 20/08/22 to 10/09/22 from our authorised Learning centre

Ravi Nagar, Nagpur.

10/09/22
Date of Issue



[Signature]
Director Signatory

S2P Edutech, 39, Bajirabhu Nagar, Behind South Indian Temple, LIT Road, Nagpur- 440010,

**S.B. JAIN INSTITUTE OF TECHNOLOGY, MANAGEMENT
& RESEARCH, NAGPUR.**

(An Autonomous Institute, Affiliated to RTMNU, Nagpur)



**CERTIFICATE OF COMPLETION
PRACTICE SCHOOL - II**

This is to certify that

Supresh Rajendra Tembhurne

of fifth semester in Computer Science and Engineering Department, has completed
3 weeks (21 days) internship, organized from **20/08/2022** to **09/09/2022** for Practice School-II, in

Software Testing

under the guidance of

Mr. Gandhar Patwardhan, S2P EDUTECH Pvt. Ltd., Nagpur

It has been found that the work accomplished is satisfactory and approved for submission.

Mr. Gandhar Patwardhan
External Mentor

Mrs. Gulrukh Nazneen
Internship Incharge

Dr. Animesh Tayal
Head of Department

**S.B. JAIN INSTITUTE OF TECHNOLOGY, MANAGEMENT
& RESEARCH, NAGPUR.**

(An Autonomous Institute, Affiliated to RTMNU, Nagpur)



**CERTIFICATE OF COMPLETION
PRACTICE SCHOOL - II**

This is to certify that

Vaishnavi Arun Kuhikar

of fifth semester in Computer Science and Engineering Department, has completed
3 weeks (21 days) internship, organized from **20/08/2022** to **09/09/2022** for Practice School-II, in

Salesforce (Admin)

under the guidance of

Mr. Rumanand Samdekar, Tavant Technology, Hyderabad

It has been found that the work accomplished is satisfactory and approved for submission.

Mrs. Sonam Chopade
Internal Mentor

Mrs. Gulrukh Nazneen
Internship Incharge

Dr. Animesh Tayal
Head of Department

**S.B. JAIN INSTITUTE OF TECHNOLOGY, MANAGEMENT
& RESEARCH, NAGPUR.**

(An Autonomous Institute, Affiliated to RTMNU, Nagpur)



**CERTIFICATE OF COMPLETION
PRACTICE SCHOOL - II**

This is to certify that

Vasu Vijay Rajurkar

of fifth semester in Computer Science and Engineering Department, has completed
3 weeks (21 days) internship, organized from **20/08/2022** to **09/09/2022** for Practice School-II, in

JavaScript and Angular JS

under the guidance of

Ms. Ashvini Tarar, Assistant Professor, SBJITMR, Nagpur

It has been found that the work accomplished is satisfactory and approved for submission.

Ms. Ashvini Tarar
Internal Mentor

Mrs. Gulrukh Nazreen
Internship Incharge

Dr. Animesh Tayal
Head of Department

**S.B. JAIN INSTITUTE OF TECHNOLOGY, MANAGEMENT
& RESEARCH, NAGPUR.**

(An Autonomous Institute, Affiliated to RTMNU, Nagpur)



**CERTIFICATE OF COMPLETION
PRACTICE SCHOOL - II**

This is to certify that

Janvi Tote

of fifth semester in Computer Science and Engineering Department, has completed
3 weeks (21 days) internship, organized from **20/08/2022** to **09/09/2022** for Practice School-II, in

Software Testing

under the guidance of

Mr. Gandhar Patwardhan, S2P EDUTECH Pvt. Ltd., Nagpur

It has been found that the work accomplished is satisfactory and approved for submission.

Mr. Gandhar Patwardhan
External Mentor

Mrs. Gulrukh Nazreen
Internship Incharge

Dr. Animesh Tayal
Head of Department



Sir Shantilal Badjate Charitable Trust's

**S. B. JAIN INSTITUTE OF TECHNOLOGY,
MANAGEMENT & RESEARCH**

NAAC ACCREDITED WITH 'A' GRADE

Hindi Linguistic Minority Institute • (Approved by AICTE, DTE & Affiliated to R.T.M. Nagpur University)

DEPARTMENT OF COMPUTER SCIENCE AND ENGINEERING

Our Vision - To become a center for quality education in the field of Computer Science & Engineering and to create competent professionals.

Date: 22/09/2022

Certificate

It is to certify that the following students of Computer Science and Engineering Department of S. B. Jain Institute of Technology Management and Research, Nagpur are working on a Live Project for session 2022-23, with Title- "**Vantage Marketing using Social Responses**", under the guidance of Mr. Raj Arora from Revat Networks and Dr. Rashmi Jain from CSE Department.

1. Daraksha Sheikh
2. Ranu Basbarile
3. Satyam Tirpude
4. Sushant Choudhari
5. Karthik Chaoji

CEO Revat Networks

Dr. Animesh Tayal

Head of CSE Department
HEAD

Dept. of Computer Science & Engineering
S. B. Jain Inst. of Tech., Mgmt. & Research
Nagpur-441501

Department of Computer Science & Engineering

Ref: SF/HRM/REC-6/2022/1563
20th July, 2022

TO WHOMSOEVER IT MAY CONCERN

This is certified that **Mr. Nilesh S. Panchbhai**, a student of **S B JAIN College Nagpur**, has completed his Vocational Training in our **Rolling Mill- A&E Department** during period **06/07/2022 to 20/07/2022** & submitted his Project Report to us.

We wish him very best for his success, growth, prosperity and abundance in his ventures ahead.

For **SUNFLAG IRON & STEEL CO. LTD.**

Satish

**SATISH SRIVASTAV
HEAD-(HRM, SAFETY & TRAINING)**



Ref: SF/HRM/REC-6/2022/1601
12th August, 2022

Bhandara Road, Warthi, Bhandara - 441 905
Tel : 07184 - 285551 To 285555
Fax : 07184 - 285740
E-mail : admin@sunflagsteel.com
Website : www.sunflagsteel.com
CIN No.: L27100MH1984PLC034003
GSTIN NO.: 27AACC33376C1ZH

TO WHOMSOEVER IT MAY CONCERN

This is certified that **Mr. Hrushabh B. Pogde**, a student of **S B Jain College Nagpur**, has completed his Vocational Training in our **MRSS** Department during period **21/07/2022 to 06/08/2022** & submitted his Project Report to us.

We wish him very best for his success, growth, prosperity and abundance in his ventures ahead.

For **SUNFLAG IRON & STEEL CO. LTD.**

Satish

SATISH SRIVASTAV
HEAD-(HRM, SAFETY & TRAINING)

CHENNAI OFFICE:
7/5, 7th FLOOR, CHALLAMALL,
11/15A, SR THAGARAYA ROAD,
T. NAGAR, CHENNAI - 600 017
TEL: 044-24342282, 24342283
24341066, 24323724
FAX: 044-24347543
E-mail: rnkj_sj@sunflagsteel.com

DELHI OFFICE:
D-47, DEFENCE COLONY,
2ND FLOOR, NEW DELHI - 110 004
TEL: 011-40576020/40576051
FAX: 011-49578020
E-mail: delhi@sunflagsteel.com

FARDABAG OFFICE:
PLOT No. 12, SECTOR 'B'
MATHURA ROAD,
FARDABAG-121 006
TEL: 0129-2311167/12
E-mail: rnkj_nc@sunflagsteel.com



MUMBAI OFFICE:
307, HAMILTON - B
HIRANANDANI BUSINESS
PARK, GHODBUNDER ROAD,
THANE - 400 607
TEL: 022-25862294, 01
25861901
E-mail: rnkj_w@sunflagsteel.com

PUNE OFFICE:
85-81, FIFTH FLOOR,
SAI KRPA BHAWAN PUNE
MUMBAI HIGHWAY, OPP. KSB
PUMP, S. No. 5742, KHARJUNDA,
PIMPRI, PUNE - 411 010
TEL: 020-27424285
FAX: 020-27423915
E-mail: rnkj_p@sunflagsteel.com

REGD. OFFICE:
33, MOUNT ROAD, SADAR
NAGPUR - 441 011 (INDIA)
PH: 25342611, 25342656,
25342658
FAX: 0712-2528350
E-Mail: rnkj_n@sunflagsteel.com





TEXTILE DIVISION

B-1, A. K. V. N. Kailash Nagar, Sausar,
Chhindwara - 480106, Madhya Pradesh
Tel: (91-07165) 226503 / 226508
Fax: (91-07165) 226512

CIN : L17117MH1925PLC001208

RL/CHH/HR/2022/07
20/07/2022

TO WHOM SOEVER IT MAY CONCERN

*This is to certify that **Mr. Ketan Tukaram Thakre**, a Student of S. B. Jain Institute of Technology Management & Research, Nagpur, undergone Industrial training in our Electrical Engineering Department from 06/07/2022 to 20/07/2022.*

He was sincere, hard working and punctual to the best of our knowledge.

We wish him all success in his future career.

FOR RAYMOND LIMITED
(Textile Division - Chhindwara)

ASHISH SHARMA
EXECUTIVE - HR&ADMN.



OFFICE
185, Ravindranath Tagore Marg,
Civil Lines, Nagpur - 440 001, India
Tel: (0712) 2535003, 2542485
Fax: (0712) 2527182

REGISTERED OFFICE
Plot No. 156/H No. 2, Village Zedgaon,
Rajnagari - 415 612, Maharashtra
Tel: (02352) 232514
Fax: (02352) 232513

Raymond
LIMITED

TEXTILE DIVISION

B. I. A. K. V. N. Kulkarni Nagar, Sector
Chhindwara - 480105, Madhya Pradesh
Tel: (91-07165) 226503 / 226508
Fax: (91-07165) 226512

CIN: L17117MH1825PLC001209

RL/CHH/HR/2022/07
20/07/2022

TO WHOM SOEVER IT MAY CONCERN

*This is to certify that **Mr. Mithilesh Likhar**, a Student of S. B. Jain Institute of Technology Management & Research, Nagpur, undergone Industrial training in our Electrical Engineering Department from 06/07/2022 to 20/07/2022.*

He was sincere, hard working and punctual to the best of our knowledge.

We wish him all success in his future career.

FOR RAYMOND LIMITED
(Textile Division - Chhindwara)

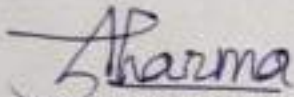

ASHISH SHARMA
EXECUTIVE - HR&ADMN.

OFFICE
165, Ravindranath Tagore Marg,
Civil Lines, Nagpur - 440 001, India
Tel: (0712) 2535003, 2542465
Fax: (0712) 2527162

REGISTERED OFFICE
Plot No. 156/H No. 2, Village Zedgaon,
Rajnagar - 415 612, Maharashtra
Tel: (02352) 232514
Fax: (02352) 232513





RAHSAN

ENGINEERING

Plot No. 29B, 28A, Mohite Industrial Area, Hingna MIDC , Hingna .0712 - 6455596,
9011576476, 8830394613 info@rahsan.in, rahsan.engineering@rediffmail.com

: RE/75/EL/22-23

Date: 29/07/2022

TO WHOM IT MAY CONCERN

This is to certify that **Ms. Sayli Kale**, a student of **S. B. JAIN INSTITUTE OF TECHNOLOGY , MANAGEMENT & RESEARCH , NAGPUR** has successfully completed 15 (fifteen) Day's (From 5th July, 2022 to 29th July, 2022) long internship programme at this company. During the period of her internship programme with us she was found punctual, hardworking and inquisitive .

We wish her every success in future.

FOR RAHSAN ENGINEERING



Authorized Signatory



RAHSAN ENGINEERING

Plot No. 29B, 28A, Mohite Industrial Area, Hingna MIDC , Hingna..0712 – 6455596,
9011576476, 8830394613 info@rahsan.in, rahsan.engineering@rediffmail.com

: RE/75/EL/22-23

Date: 29/07/2022

TO WHOM IT MAY CONCERN

This is to certify that **Ms. Vrushali Dongarwar**, a student of **S. B. JAIN INSTITUTE OF TECHNOLOGY , MANAGEMENT & RESEARCH , NAGPUR** has successfully completed 15 (fifteen) Day's (From 5th July, 2022 to 29th July, 2022) long internship programme at this company. During the period of her internship programme with us she was found punctual, hardworking and inquisitive .

We wish her every success in future.

FOR RAHSAN ENGINEERING

Authorized Signatory



RAHSAN ENGINEERING

Plot No. 29B, 28A, Mohite Industrial Area, Hingna MIDC , Hingna .0712 - 6455596,
9011576476, 8830394613 info@rahsan.in, rahsan.engineering@rediffmail.com

: RE/75/EL/22-23

Date: 29/07/2022

TO WHOM IT MAY CONCERN

This is to certify that Ms. Tejaswini Umbarkar, a student of S. B. JAIN INSTITUTE OF TECHNOLOGY , MANAGEMENT & RESEARCH , NAGPUR has successfully completed 15 (fifteen) Day's (From 5th July, 2022 to 29th July, 2022) long internship programme at this company. During the period of her internship programme with us she was found punctual, hardworking and inquisitive .

We wish her every success in future.

FOR RAHSAN ENGINEERING

Authorized Signatory



RAHSAN ENGINEERING

Plot No. 29B, 28A, Mohite Industrial Area, Hingna MIDC , Hingna..0712 – 6455596,
9011576476, 8830394613 info@rahsan.in, rahsan_engineering@rediffmail.com

: RE/75/EL/22-23

Date: 29/07/2022

TO WHOM IT MAY CONCERN

This is to certify that **Ms.Shruti Kshirsagar**, a student of **S. B. JAIN INSTITUTE OF TECHNOLOGY , MANAGEMENT & RESEARCH , NAGPUR** has successfully completed 15 (fifteen) Day's (From 5th July, 2022 to 29th July, 2022) long internship programme at this company. During the period of her internship programme with us she was found punctual, hardworking and inquisitive .

We wish her every success in future.

FOR RAHSAN ENGINEERING

Authorized Signatory

IGTR/NGP/2022-23/ 57

Saturday, August 27, 2022

TO WHOME SO EVER IT MAY CONCERN

This is to certify that following students of S. B. Jain Institute of Technology, Management & Research Nagpur had successful completed Fifteen Days training program on **ELECTRICAL CAD** at MSME Technology Center, Indo German Tool Room, Aurangabad Extension Center, Nagpur from 04/07/22 to 20/07/2022.

1. ASHVINI GOWARDHAN BAREKAR.
2. ROHIT RAJU SHENDE.
3. PRACHI MANOJ WALDE.
4. PRAJWAL AVINASH DAMBHARE.
5. DIPENDRA PADAMLAL KHOBRADE.
6. SHREYASH CHANDRAKUMAR BANSOD.
7. SNEHA VIJAY CHAUHAN.
8. PRATHMESH JITENDRA SOMKUWAR.
9. ABHITOSH SANTOSH SHIRSAT.

For, MSME IGTR Aurangabad EC, Nagpur



I. Haque



Engineer(CAD/CAM)

P-142, M.I.D.C. INDUSTRIAL AREA, HINGNA, NAGPUR – 440028 (M.S.) INDIA

Email : training_ngp@igtr-aur.org, Web-site : www.igtr-au.org

Phone : (07104)-297136, Mob. No. : 9075095552



INDO GERMAN TOOL ROOM, AURANGABAD
(A Government of India Society, Ministry of MSME)
EXTENSION CENTRE - NAGPUR



IGTR/NGP/2022-23/ 28

Saturday, August 6, 2022

CERTIFICATE

This is to certify that **Ms. NAGDEVE NISHA SHARAD** student of S. B. Jain Institute of Technology, Management & Research Nagpur had successful completed Fifteen Days **ELECTRICAL CAD** at MSME Technology Center, Indo German Tool Room, Aurangabad Extension Center, Nagpur from 04/07/22 to 20/07/2022.

For, MSME IGTR Aurangabad EC, Nagpur

I. Haque

Engineer(CAD/CAM)



P-142, M.I.D.C. INDUSTRIAL AREA, HINGNA, NAGPUR - 440028 (M.S.) INDIA

Email : training_ngp@igtr-aur_018, Web-site : www.igtr-aur_018

Phone : (07104)-297136, Mob. No. : 9075095552



INDO GERMAN TOOL ROOM, AURANGABAD
(A Government of India Society, Ministry of MSME)
EXTENSION CENTRE - NAGPUR



IGTR/NGP/2022-23/ 28

Saturday, August 6, 2022

CERTIFICATE

This is to certify that Ms. SANGODE AAKANKSHA NANDKISHOR student of S. B. Jain Institute of Technology, Management & Research Nagpur had successfully completed Fifteen Days **ELECTRICAL CAD** at MSME Technology Center, Indo German Tool Room, Aurangabad Extension Center, Nagpur from 04/07/22 to 20/07/2022.

For, MSME IGTR Aurangabad EC, Nagpur

I. Haque

Engineer(CAD/CAM)



P-142, M.I.D.C. INDUSTRIAL AREA, HINGNA, NAGPUR – 440028 (M.S.) INDIA

Email : training_ngp@igtr-aur.org, Web-site : www.igtr-ai.org

Phone : (07104)-297136, Mob. No. : 9075095552



Certificate of Internship

This is to certify that **Ms.Nikita Batulal Nagpure**, a student of BE Electrical Engineering, S.B. Jain Institute of Technology, Management and Research, Nagpur, Maharashtra has completed an internship program from 18th July 2022 to 7th August, 2022 at Saurabh Engineering Services, Nagpur, under the guidance of Mr Waqas Aamir. During the period of her internship program with us, she was found punctual, hardworking, and inquisitive.

We wish her every success in life.

For Saurabh Engineering Services.



[Signature]
Authorized Signature

- Electrical Safety, Energy Auditors & Electrical Engineering Consultants
- Registered with MEDA, PCRA, GEDA, HPCL, BPCL & IDCL

Off. Add: H.No.569/11, Shri Niwas Apartment, Mukunraj Galli, Walker Road, Mahal, Nagpur-440032 (M.H.)

Email: sesatongpe@gmail.com, srbhattad@gmail.com | Website : www.saurabhengineering.com

Ph. No. : 0712-2730112, Mob. : 09762190101, 07972427997, 08626032960



Certificate of Internship

This is to certify that **Ms.Priti Balaram Chakole**, a student of BE Electrical Engineering, S.B. Jain Institute of Technology, Management and Research, Nagpur, Maharashtra has completed an internship program from 18th July 2022 to 7th August, 2022 at Saurabh Engineering Services, Nagpur, under the guidance of Mr. Waqas Aamir. During the period of her internship program with us, she was found punctual, hardworking, and inquisitive.

We wish her every success in life.

For Saurabh Engineering Services.



Authorized Signature

- Electrical Safety, Energy Auditors & Electrical Engineering Consultants
- Registered with MEDA, PCRA, GEDA, HPCL, BPCL & IOCL

Off. Add: H.No.569/11, Shri Niwas Appartment, Mukunraj Gaili, Walker Road, Mahal, Nagpur-440032 (M.H.)
Email: sesinfongp@gmail.com, sdbhattad@gmail.com | Website : www.saurabhengineering.com
Ph. No.: 0712-2730112, Mob.: 09763190151, 07972427997, 08626032960



Certificate of Internship

This is to certify that **Mr. Ravikant Purushottam Tarare**, a student of BE Electrical Engineering, S.B. Jain Institute of Technology, Management and Research, Nagpur, Maharashtra has completed an internship program from 18th July 2022 to 7th August, 2022 at Saurabh Engineering Services, Nagpur, under the guidance of Mr. Waqas Aamir. During the period of his internship program with us, he was found punctual, hardworking, and inquisitive.

We wish him every success in life.

For Saurabh Engineering Services.

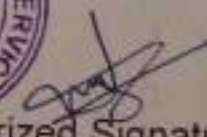

Authorized Signature

- Electrical Safety, Energy Auditors & Electrical Engineering Consultants
- Registered with MEDA, PCRA, GEDA, HPCL, BPCL & IOCL

Off. Add: H.No.569/11, Shri Niwas Appartment, Mukunraj Galli, Walker Road, Mahal, Nagpur-440032 (M.H.)

Email: sesinfongp@gmail.com, sdbhattad@gmail.com | Website : www.saurabhengineering.com

Ph. No.: 0712-2730112, Mob.: 09763190151, 07972427997, 08626032960



Certificate of Internship

This is to certify that **Ms. Manisha Pralhad Sonewane**, a student of BE Electrical Engineering, S.B. Jain Institute of Technology, Management and Research, Nagpur, Maharashtra has completed an internship program from 18th July 2022 to 7th August, 2022 at Saurabh Engineering Services, Nagpur, under the guidance of Mr. Waqas Aamir. During the period of her internship program with us, she was found punctual, hardworking, and inquisitive.

We wish her every success in life.

For Saurabh Engineering Services.



Authorized Signature

- Electrical Safety, Energy Auditors & Electrical Engineering Consultants
- Registered with MEDA, PCRA, GEDA, HPCL, BPCL & IOCL

Off. Add: H.No.569/11, Shri Niwas Appartment, Mukunraj Galli, Walker Road, Mahal, Nagpur-440032 (M.H.)
Email: sesintongp@gmail.com, sdbhattad@gmail.com | Website : www.saurabhengineering.com
Ph. No.: 0712-2730112, Mob.: 09763190151, 07972427997, 08626032960



Certificate of Internship

This is to certify that **Ms. Minal Yashwant Bhivgade**, a student of BE Electrical Engineering, S.B. Jain Institute of Technology, Management and Research, Nagpur, Maharashtra has completed an internship program from 14th June 2022 to 25th July, 2022 at Saurabh Engineering Services, Nagpur, under the guidance of Mr. Waqas Aamir. During the period of her internship program with us, she was found punctual, hardworking, and inquisitive.

We wish her every success in life.

For Saurabh Engineering Services.



Authorized Signature

- Electrical Safety, Energy Auditors & Electrical Engineering Consultants
- Registered with MEDA, PCRA, GEDA, HPCL, BPCL & IOCL



Certificate of Internship

This is to certify that **Ms. Punam Naresh Bhagat**, a student of BE Electrical Engineering, S.B. Jain Institute of Technology, Management and Research, Nagpur, Maharashtra has completed an internship program from 14th June 2022 to 25th July, 2022 at Saurabh Engineering Services, Nagpur, under the guidance of Mr. Waqas Aamir. During the period of her internship program with us, she was found punctual, hardworking, and inquisitive.

We wish her every success in life.

For Saurabh Engineering Services.

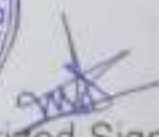

Authorized Signature

- Electrical Safety, Energy Auditors & Electrical Engineering Consultants
- Registered with MEDA, PCRA, GEDA, HPCL, BPCL & IOCL



Certificate of Internship

This is to certify that Ms. Janhvi Tekade, a student of B. Tech Electrical Engineering, S.B. Jain Institute of Technology, Management and Research, Nagpur, Maharashtra has completed an internship program from 18th July, 2022 to 07th Aug, 2022 at Saurabh Engineering Services, Nagpur under the guidance of Mr. M. Waqas Aamir. During the period of her internship program with us, she was found punctual, hardworking, and inquisitive. We wish her every Success in life.

For Saurabh Engineering Services.



Authorized Signature

■ Electrical Safety & Energy Auditors, Electrical Engineering Consultants

■ Registered with MEDA, GEDA, HPCL, BPCL & IOCL

Off Add.: Shri Niwas Appartment, H.No. 569/11, Mukunraj Galli, Walker Road, Mahal, Nagpur-440032 (M.H.)

Email: saurabhes@gmail.com, sdbhattad@gmail.com, www.saurabhengineering.com

Ph. No.: 0712-2730112, Mob.: +91 9763190151, 7972427997, 7387470334



GENTECH SOLAR LLP

MR 1 HABITAT HANSRAJ,
OPP. SHREE BAIDHYNATH BHAWAN, GREAT NAG ROAD,
NAGPUR-440009
GST No.27AAUFG1005B1ZT

CERTIFICATE OF INTERNSHIP

Date:- 30/07/22

TO WHOM IT MAY CONCERN

This is to certify that Miss. Prachi Vitthalrao Dehanikar a student of B.E (Electrical Engineering) of **S.B. Jain Institute of Technology, Management and Research, Nagpur** has successfully completed Internship Programme for a period of 20 Days , from 5 July, 2022 to 25 July, 2022 at **GENTECH SOLAR LLP**. During the period of her/his Internship Programme with us he/she was found punctual, hardworking and inquisitive.

We wish her/him every success in life and career.

Place: Nagpur

For Gentech Solar LLP



Vivek Singh Gaherwar



GENTECH SOLAR LLP

MR 1 HABITAT HANSRAJ
OPP. SHREE BAIDHYNATH BHAWAN, GREAT NAG ROAD
NAGPUR-440009
GST No. 27AAUFG1005B1ZT

CERTIFICATE OF INTERNSHIP

Date:- 30/07/22

TO WHOM IT MAY CONCERN

This is to certify that Miss. Shivani Maheshwarsingh Rathod a student of B.E (Electrical Engineering) of **S.B. Jain Institute of Technology, Management and Research, Nagpur** has successfully completed Internship Programme for a period of 20 Days , from 5 July, 2022 to 25 July, 2022 at **GENTECH SOLAR LLP**. During the period of her/his Internship Programme with us he/she was found punctual, hardworking and inquisitive.

We wish her/him every success in life and career.

Place: Nagpur

For Gentech Solar LLP



Vivek Singh Gaherwar



GENTECH SOLAR LLP

MR 1 HABITAT HANSRAJ,
OPP. SHREE BAIDHYNATH BHAWAN, GREAT NAG ROAD,
NAGPUR-440009
GST No.27AAUFG1005B1ZT

CERTIFICATE OF INTERNSHIP

Date:- 30/07/22

TO WHOM IT MAY CONCERN

This is to certify that Mr. **Dushyant Krishnachandra Tiwari** a student of B.E (Electrical Engineering) of **S.B. Jain Institute of Technology, Management and Research, Nagpur** has successfully completed Internship Programme for a period of 20 Days , from 5 July, 2022 to 25 July, 2022 at **GENTECH SOLAR LLP**. During the period of her/his Internship Programme with us he/she was found punctual, hardworking and inquisitive.

We wish her/him every success in life and career.

Place: Nagpur

For Gentech Solar LLP



Vivek Singh Gaherwar



GENTECH SOLAR LLP

MR 1 HABITAT HANSRAJ,
OPP. SHREE BAIDHYNATH BHAWAN, GREAT NAG ROAD,
NAGPUR- 440009
GST No.27AAUFG1005B1ZT

CERTIFICATE OF INTERNSHIP

Date:- 30/07/22

TO WHOM IT MAY CONCERN

This is to certify that Miss Nikita Mitendra Ghatolkar a student of B.E (Electrical Engineering) of **S.B. Jain Institute of Technology, Management and Research, Nagpur** has successfully completed Internship Programme for a period of 20 Days , from 5 July, 2022 to 25 July, 2022 at **GENTECH SOLAR LLP**. During the period of her/his Internship Programme with us he/she was found punctual, hardworking and inquisitive.

We wish her/him every success in life and career.

Place: Nagpur

For Gentech Solar LLP



Vivek Singh Gaherwar



CONFIDENCE PETROLEUM (I) LTD. (MCPL UNIT)

Ragd. Office : 404, Satyam Apartment , 08 Wardha Road , Nagpur
Email : mcpl@confidencegroup.co

Work : Near Kalmeshwar Railway Station, Kalmeshwar distt:- Nagpur, 441501

Ref:CPIL/SBJ/2021-2022/47

Dated- 02-08-2022

CERTIFICATE

This is to certify that Miss. Deepanshi Kalmegh, a student of Electrical Engineering Department, S.B. Jain Institute of Technology, Management & Research has undergone internship training at our empty LPG cylinder manufacturing plant from 15-07-2022 to 31-07-2022.

She was sincere, hardworking and punctual to the best of our knowledge.

We wish her success in his entire endeavor.

For Confidence Petroleum (I) Limited. (MCPL Unit)

PRASHANT M. KUMAR
MANAGER
CONFIDENCE PETROLEUM (I) LTD
NEAR KALMESHWAR RAILWAY STATION
KALMESHWAR 441501



CONFIDENCE PETROLEUM (I) LTD. (MCPL UNIT)

Ragd. Office : 404, Satyam Apartment , 08 Wardha Road , Nagpur
Email : mcpl@confidencegroup.co

Work : Near Kalmeshwar Railway Station, Kalmeshwar distt:- Nagpur, 441501

Ref:CPIL/SBJ/2021-2022/47

Dated- 02-08-2022

CERTIFICATE

This is to certify that Mr. Hitesh Dabre, a student of Electrical Engineering Department, S.B. Jain Institute of Technology, Management & Research has undergone internship training at our empty LPG cylinder manufacturing plant from 15-07-2022 to 31-07-2022.

He was sincere, hardworking and punctual to the best of our knowledge.

We wish him success in his entire endeavor.

For Confidence Petroleum (I) Limited. (MCPL Unit)

PRASHANT M. GHUMDE
QC INCHARG
CONFIDENCE PETROLEUM (I) LTD
NEAR KALMESHWAR RAILWAY STATION
KALMESHWAR 441501



CONFIDENCE PETROLEUM (I) LTD. (MCPL UNIT)

Ragd. Office : 404, Satyam Apartment , 08 Wardha Road , Nagpur
Email : mcpl@confidencegroup.co

Work : Near Kalmeshwar Railway Station, Kalmeshwar distt:- Nagpur, 441501

Ref:CPIL/SBJ/2021-2022/47

Dated- 02-08-2022

CERTIFICATE

This is to certify that Mr. Khoneshwar Dhawle, a student of Electrical Engineering Department, S.B. Jain Institute of Technology, Management & Research has undergone internship training at our empty LPG cylinder manufacturing plant from 15-07-2022 to 31-07-2022.

He was sincere, hardworking and punctual to the best of our knowledge.

We wish him success in his entire endeavor.

For Confidence Petroleum (I) Limited. (MCPL Unit)

PRASHANT M. GHUMDE
IN CHARGE
CONFIDENCE PETROLEUM (I) LTD
NEAR KALMESHWAR RAILWAY STATION
KALMESHWAR 441501



CONFIDENCE PETROLEUM (I) LTD. (MCPL UNIT)

Ragd. Office : 404, Satyam Apartment , 08 Wardha Road , Nagpur
Email : mcpl@confidencegroup.co

Work : Near Kalmeshwar Railway Station, Kalmeshwar distt:- Nagpur, 441501

Ref:CPIL/SBJ/2021-2022/47

Dated- 02-08-2022

CERTIFICATE

This is to certify that Mr. Rohan Tarte, a student of Electrical Engineering Department, S.B. Jain Institute of Technology, Management & Research has undergone internship training at our empty LPG cylinder manufacturing plant from 15-07-2022 to 31-07-2022.

He was sincere, hardworking and punctual to the best of our knowledge.

We wish him success in his entire endeavor.

For Confidence Petroleum (I) Limited. (MCPL Unit)

PRASHANT M. GHUMDE
DODDARWADI
CONFIDENCE PETROLEUM (I) LTD
NEAR KALMESHWAR RAILWAY STATION
KALMESHWAR - 441501

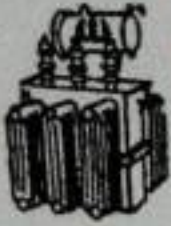

ASIAN ELECTRICALS

Factory & Office : C - 20 / 1, MIDC, Hingna Industrial Estate, Nagpur - 28

Fact. & Off. ☎ 07104-237844, Email : asianelectricals75@gmail.com

MANUFACTURERS & REPAIRER OF POWER & DISTRIBUTION TRANSFORMERS

APPROVED GOVT. ELECTRICAL CONTRACTOR - Licence No. MC - 2523

CERTIFICATE

This is to certify that Vaibhav Adhav, 3rd Year, 6th Semester, Student of S.B, Jain Institute of Technology, Management & Research, Nagpur, Branch Electrical Engineering has successfully completed One Month Industrial training from 05/07/2022 to 20/07/2022 at M/s ASIAN ELECTRICALS, MIDC, NAGPUR in the year 2022.

During the Industrial Training, he gained the knowledge about Distribution Transformer repairing & manufacturing process and explained about transformer core/lamination assembly, Coil winding process, Insulation of Core & winding, Coil fitting process, complete assembly of core & winding, Star & Delta Connections, Moisture removal process in Oven (i.e. in Heating chamber), Tanking procedure, filling of oil through Filter machine & Painting the transformer. He also gained the knowledge about transformer testing i.e Ratio Test, No load test, Full load test, High voltage test, Short circuit test, DVDF Test, Insulation test (Meggering), Oil test etc.

We wish him success & bright future.

Date:- 17/11/2022

Place:- NAGPUR



For Asian Electricals

Vaibhav
Partner

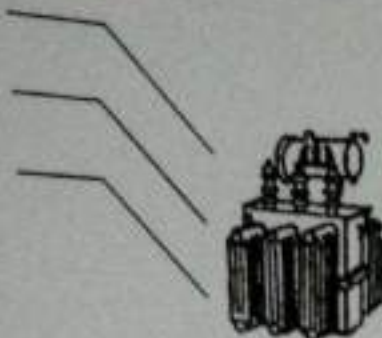

ASIAN ELECTRICALS

Factory & Office : C - 20 / 1, MIDC, Hingna Industrial Estate, Nagpur - 28
Fact. & Off. ☎ 07104-237844, Email : asianelectricals75@gmail.com
MANUFACTURERS & REPAIRER OF POWER & DISTRIBUTION TRANSFORMERS
APPROVED GOVT. ELECTRICAL CONTRACTOR - Licence No. MC - 2523

CERTIFICATE

This is to certify that Shubham Sakhare, 3rd Year, 6th Semester, Student of S.B. Jain Institute of Technology, Management & Research, Nagpur, Branch Electrical Engineering has successfully completed One Month Industrial training from 05/07/2022 to 20/07/2022 at M/s ASIAN ELECTRICALS, MIDC, NAGPUR in the year 2022.

During the Industrial Training, he gained the knowledge about Distribution Transformer repairing & manufacturing process and explained about transformer core/lamination assembly, Coil winding process, Insulation of Core & winding, Coil fitting process, complete assembly of core & winding, Star & Delta Connections, Moisture removal process in Oven (i.e. in Heating chamber), Tanking procedure, filling of oil through Filter machine & Painting the transformer. He also gained the knowledge about transformer testing i.e Ratio Test, No load test, Full load test, High voltage test, Short circuit test, DVDF Test, Insulation test (Meggering), Oil test etc.

We wish him success & bright future.

Date:- 17/11/2022

Place:- NAGPUR



For Asian Electricals
Shubham Sakhare
Partner



ASIAN ELECTRICALS

Factory & Office : C - 20 / 1, MIDC, Hingna Industrial Estate, Nagpur - 28

Fact. & Off. ☎ 07104-237844, Email : asianelectricals75@gmail.com

MANUFACTURERS & REPAIRER OF POWER & DISTRIBUTION TRANSFORMERS

APPROVED GOVT. ELECTRICAL CONTRACTOR - Licence No. MC - 2523

CERTIFICATE

This is to certify that Aditya Bhendare, 3rd Year, 6th Semester, Student of S.B. Jain Institute of Technology, Management & Research, Nagpur, Branch Electrical Engineering has successfully completed One Month Industrial training from 05/07/2022 to 20/07/2022 at M/s ASIAN ELECTRICALS, MIDC, NAGPUR in the year 2022.

During the Industrial Training, he gained the knowledge about Distribution Transformer repairing & manufacturing process and explained about transformer core/lamination assembly, Coil winding process, Insulation of Core & winding, Coil fitting process, complete assembly of core & winding, Star & Delta Connections, Moisture removal process in Oven (i.e. in Heating chamber), Tanking procedure, filling of oil through Filter machine & Painting the transformer. He also gained the knowledge about transformer testing i.e. Ratio Test, No load test, Full load test, High voltage test, Short circuit test, DVDF Test, Insulation test (Meggering), Oil test etc.

We wish him success & bright future.

Date:- 17/11/2022

Place:- NAGPUR



For Asian Electricals

Partner

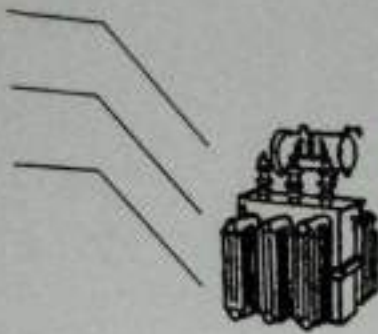

ASIAN ELECTRICALS

Factory & Office : C - 20 / 1, MIDC, Hingna Industrial Estate, Nagpur - 28

Fact. & Off. ☎ 07104-237844, Email : asianelectricals75@gmail.com

MANUFACTURERS & REPAIRER OF POWER & DISTRIBUTION TRANSFORMERS

APPROVED GOVT. ELECTRICAL CONTRACTOR - Licence No. MC - 2523

CERTIFICATE

This is to certify that Mandar Pal, 3rd Year, 6th Semester, Student of S.B. Jain Institute of Technology, Management & Research, Nagpur, Branch Electrical Engineering has successfully completed One Month Industrial training from 05/07/2022 to 20/07/2022 at M/s ASIAN ELECTRICALS, MIDC, NAGPUR in the year 2022.

During the Industrial Training, he gained the knowledge about Distribution Transformer repairing & manufacturing process and explained about transformer core/lamination assembly, Coil winding process, Insulation of Core & winding, Coil fitting process, complete assembly of core & winding, Star & Delta Connections, Moisture removal process in Oven (i.e. in Heating chamber), Tanking procedure, filling of oil through Filter machine & Painting the transformer. He also gained the knowledge about transformer testing i.e Ratio Test, No load test, Full load test, High voltage test, Short circuit test, DVDF Test, Insulation test (Meggering), Oil test etc.

We wish him success & bright future.

Date:- 17/11/2022

Place:- NAGPUR



For Asian Electricals

Sriharde
Partner



ASIAN ELECTRICALS

Factory & Office : C - 20 / 1, MIDC, Hingna Industrial Estate, Nagpur - 28

Fact. & Off. ☎ 07104-237844, Email : asianelectricals75@gmail.com

MANUFACTURERS & REPAIRER OF POWER & DISTRIBUTION TRANSFORMERS

APPROVED GOVT. ELECTRICAL CONTRACTOR - Licence No. MC - 2523

CERTIFICATE

This is to certify that Ayush Dambhare , 3rd Year , 6th Semester, Student of S.B. Jain Institute of Technology, Management & Research, Nagpur, Branch Electrical Engineering has successfully completed One Month Industrial training from 05/07/2022 to 20/07/2022 at M/s ASIAN ELECTRICALS, MIDC, NAGPUR in the year 2022.

During the Industrial Training, he gained the knowledge about Distribution Transformer repairing & manufacturing process and explained about transformer core/lamination assembly, Coil winding process, Insulation of Core & winding , Coil fitting process, complete assembly of core & winding, Star & Delta Connections, Moisture removal process in Oven (i.e. in Heating chamber), Tanking procedure , filling of oil through Filter machine & Painting the transformer. He also gained the knowledge about transformer testing i.e Ratio Test, No load test, Full load test, High voltage test, Short circuit test, DVDF Test, Insulation test (Meggering) , Oil test etc.

We wish him success & bright future.

Date:- 17/11/2022

Place:- NAGPUR



For Asian Electricals

Srihabale
Partner

BHARAT UDYOG

Manufacturers, Engineers, Trader & Fabricators

Mfg. of : Electrical Control Pannel, Distribution Box, Outdoor Feeder Pillars, Swage Pole, and Fabrication of MSEDCL HT / LT Line Material & Trader of all type of electrical goods

Date: 05/08/2022

TO WHOM IT MAY CONCERN

This is to certify that Ms. Shweta N. Dahake, a student of VI sem Electrical Engineering, S B Jain Institute of Technology, Management & Research, Katol Road, Nagpur has successfully completed 30 days "Industrial Training cum Internship" from 5th July to 4th Aug 2022 at this company.

During the Period of her Internship with us she was found punctual, hardworking and inquisitive.

We wish her all the best for her upcoming career.

Bharat Udyog

Authorized



Date : 05/08/2022

TO WHOM IT MAY CONCERN

This is to certify that Ms. Sakshi D. Dhawale, a student of VI sem Electrical Engineering, S B Jain Institute of Technology, Management & Research, Katol Road, Nagpur has successfully completed 30 days "Industrial Training cum Internship" from 5th July to 4th Aug 2022 at this company.

During the Period of her Internship with us she was found punctual, hardworking and inquisitive.

We wish her all the best for her upcoming career.

Bharat Udyog

For [Signature]

Authorized Sign.





M/s Jagatshree Engineering



◆ Electrical & Power Cabling Work ◆ Sub Station Erection Work ◆ Civil & Building Construction Works
◆ All Type of RCC Work ◆ Telecom Cable Construction Works

House NO. 543, Ward No. 123, Behind Araya Samaj Mandir, Loharpura, Central Avenue, Nagpur - 440 018
Mob. No. : 7304260854, 9822670339

Date: 30th July 2022

INTERNSHIP CERTIFICATE

TO WHOMSOEVER IT MAY CONCERN

This is to certify that Mast. Tejansh Dixit, student of S.B. Jain institute of technology, management and research has completed 30 days internship training in our organization from 1st March, 22 to 1st April 2022.

During this period he has been giving exposure to underground cable laying process which included the following:

Study of different types of cable used in 11kV distribution which are classified according to the type of insulation and armouring used.

Analysis and observation of underground direct cable laying process for the purpose of 11kV distribution

Study of site inspection processes involved in the process of cable laying before starting the work.

We wish him all the best for all his future endeavors.

For JAGATSHREE ENGINEERING

Partner



M/s Jagatshree Engineering



◆ Electrical & Power Cabling Work ◆ Sub Station Erection Work ◆ Civil & Building Construction Works
◆ All Type of RCC Work ◆ Telecom Cable Construction Works

House NO. 543, Ward No. 123, Behind Araya Samaj Mandir, Loharpura, Central Avenue, Nagpur - 440 018
Mob. No. : 7304260854, 9822670339

Date: 30th July 2022

INTERNSHIP CERTIFICATE

TO WHOMSOEVER IT MAY CONCERN

This is to certify that Ms. Srishti Singh, student of S.B. Jain institute of technology, management and research has completed 15 days internship training in our organization from 16th July 2022 to 31st July 2022.

During this period she has been giving exposure to underground cable laying process which included the following:

Study of different types of cable used in 11kV distribution which are classified according to the type of insulation and armoring used.

Analysis and observation of underground direct cable laying process for the purpose of 11kV distribution

Study of site inspection processes involved in the process of cable laying before starting the work.

She has shown initiative and drive in doing her duty with sincerity and her performance was also found good. She also bears a good character and conduct.

We wish her all the best for all her future endeavors.

For JAGATSHREE ENGINEERING

Partner

Ref. No: SIPL/2022/100701

Date: 10th July 2022

INTERNSHIP CERTIFICATE

To whom so ever it may concern:

This is to certify that **Falguni S. Chambhare**, Employee ID No. **E0082**, a student of **S.B. Jain College of Engineering and Technology, RTMNU**, has completed the internship program of 30 days as an Application Testing Support Intern at **Splashjet Inkjet Ink Private Limited** starting from 10th June 2022 to 10th July 2022.

She efficiently contributed to the work and was hard-working, keen to learn & ready to accept responsibilities.

Department: Application Testing & Support

Internship Schedule: 09:00 AM to 06:00 PM

We wish her all the best in her future endeavors

For Splashjet Inkjet Ink Pvt Ltd

Mr. Prashant Dongare
(Hr Manager)



SPLASHJET INKJET INK PRIVATE LIMITED

Regd. Work Address : Shed - "B" Plot No D-1/A & D-4/2
Midc Hingna, Nagpur - 440016

Regd. Office Address : Plot No. D-4/2, GALA NO 03,
MIDC Hingna, Nagpur, Maharashtra Pin-440016 INDIA

Contact No : +91-73910-66705
E-mail : sipl@splashjet-ink.com
Website : www.splashjet-ink.com
CIN : U31900MH2020PTC335738



**MALU PAPER
MILLS LTD.**

"HEERA PLAZA" 4 th Floor,
Near Telephone Exchange,
Central Avenue, Nagpur- 08.
Ph. No. : 2760308, 2778506, (F) 2760310
Web : www.malupaper.com
e-mail : info@malupaper.com,
CIN No. : L15142MH1994PLC076009

TO WHOM SO EVER IT MAY CONCERN

Date:-30/07/2022

This is to certify that **Mr. Sharad Bagde** a student of Electrical Engineering ,
S.B. Jain Institute of Technology, Management & Research Nagpur has successfully
completed 2 weeks (From 14th July 2022 to 29th July 2022) long Internship
programme with us. He was punctual hardworking and inquisitive.

We wish him every success in life.

For Malu Paper Mills Ltd. Unit-III

Ajay Jasu
Authorised Signatory



Unit II : Village Borujwada, Nagpur Saoner Road, Taluka- Saoner , Dist. Nagpur - 441 107.
Unit III : Village hetu (Surla), Saoner Industrial Area, Taluka- Saoner, Dist. Nagpur - 441 107.

वेस्टर्न कोलफील्ड्स लिमिटेड

(भारत सरकार का उपक्रम)
(एक मिनिस्ट्रल कंपनी)
(कोल इंडिया लिमिटेड की एक सहायक कंपनी)
उपक्षेत्रीय प्रबंधक, सावनेर उपक्षेत्र



Western Coalfields Limited

(A Miniratna Company)
(A Govt. Of India Enterprise)
(A Subsidiary of Coal India Limited)
Office of the Sub Area Manager,
Saoner Sub Area

CIN U10102MH1975GOI018623

Website-westerncoal.nic.in

दस्तावेज क्र. Ref. No:वेकोली/ उ.क्षे.प्रासाव. परी./2022/ 240

दिनांक: 06.09.22

TO WHOMSOEVER IT MAY CONCERN

This is to certify that Ms. Aboli Dilip Lad, D/o Shri Dilip Lad, a student of S.B Jain Institute of Technology, Management and Research, Nagpur has undergone training at Electrical & Mechanical Department, WCL, Saoner Sub Area under the supervision of Sub Area Engineer(E&M). She was exposed to 11KV transformer and other electrical related works for a period of 15days from 6/8/22.

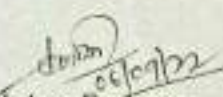
Sub Area Engineer
Saoner Sub Area
WCL, Saoner

VIP ELECTRICALS AND SERVICES

GOVT. ELECTRICAL CONTRACTOR/SUPPLIER

Lic. No.: 4353100173

GST No. 27EXHPP3830B1ZK

Near Chhindwara Road W. No. 12, Saoner - 441107

E-mail: vipelectricals17@gmail.com

Cell: 8007266318, 9561066840 9860551200

Ref No. v/0001

Date: 04/08/2022

TO WHOM IT MAY CONCERN

This is to certify that Ms. Sakshi Bonde (ID No: EL19013) a student of Bachelor of Engineering (Electrical Engineering) from S.B. Jain Institute of Technology, Management and Research, Nagpur has successfully Completed 15 days (From 16th July, 2022 to 2nd August, 2022) internship program from VIP Electrical & Services, Nagpur. During the period of internship program with us, she gained an understanding of installations and testing of Street light poles. She was found punctual, hardworking and inquisitive.

We wish her every success in life.

Authorised Signature



Adani Power Training & Research Institute (APTRI)

Certificate of Internship

This is to certify that **Ms. Bhawana kanhaiyya Patle** a Student of Third year **B.E (Electrical Engineering) S.B Jain Institute of Technology Management and Research, Nagpur** had undergone Summer **Internship** in "Design philosophy, operation and working of coal base thermal power plant" from **08/06/2022** to **21/06/2022**.

Her performance during the training period was found very Good.

We wish all success in her future endeavors.



Dr. Vijay V Gandhewar
GM (Tech. Training)



Hindalco/HR/FY-23/Cert/1367

10th August, 2022

TO WHOMSOEVER IT MAY CONCERN

This is to certify that **Mr. Vishal Dhoble** student of B.E in Electrical Engineering Studies from **S. B. Jain Institute of Technology, Management & Research, Nagpur** has undergone Internship training in our organization.

Period of training was **22/07/2022 to 10/08/2022**.

We wish him every success in his future studies and career.

For **HINDALCO INDUSTRIES LTD. MOUDA WORKS**

Vikrant Sardeshpande
Senior General Manager- HR & IR



REDMI NOTE 6 PRO
MI DUAL CAMERA

Hindalco Industries Limited

Plot No. 1, Ramtek Road, Mouda-441104, District : Nagpur, Maharashtra, India

T: +91 715 284705 | E: hindalco@adityabirla.com | W: www.hindalco.com

Registered Office : Ahuja Centre, 1st Floor, B Wing, Manakal Caves Road, Andheri (East), Mumbai 400 093, T: +91 22 6691 7000 | Fax : +91 22 6691 7001

Corporate ID No. : L27020MH1958PLC011231

Certificate of Training

Prachi Lapkale

has successfully completed a 6-week online training on **Core Java**. The training consisted of Getting Started with Java, Leveraging Basic Concepts, Object Oriented Programming, and Java App Development modules.

In the final assessment, Prachi scored 80% marks.

We wish Prachi all the best for future endeavours.



Sarvesh Agarwal

FOUNDER & CEO, INTERNSHALA

Date of certification: 2022-08-04

Certificate no. : 0ADDF114-DC85-573A-8243-44F71DFF56BE

For certificate authentication, please visit https://trainings.internshala.com/verify_certificate

Certificate of Training

Siddhi Patil

from S. B. Jain Institute of Technology, Management and Research, Nagpur has successfully completed a 6-week online training on **Data Science**. The training consisted of Introduction to Data Science, Python for Data Science, Understanding the Statistics for Data Science, Predictive Modeling and Basics of Machine Learning, and The Final Project modules.

In the final assessment, Siddhi scored 82% marks.
We wish Siddhi all the best for future endeavours.



Sarvesh Agarwal

FOUNDER & CEO, INTERNSHALA

Date of certification: 2022-08-01

Certificate no. : 6F1282CD-1338-FFE1-F507-6254DDC4A1B0

For certificate authentication, please visit https://trainings.internshala.com/verify_certificate

HRS

HRS ENTERPRISES

Specialist in electrical construction and installation works.

Address: Banda Nawaz Nagar, Plot no. 124, Gali no. 10, Behind HNGC Cancer Hospital,
Nagpur 440026

Date: 30/09/2022

TO WHOMSOEVER IT MAY CONCERN

This is to certify that **samir Deogirkar** has done his internship in HRS Enterprises, Nagpur, from 20th July 2022 to 22nd August 2022. As part of the project, he has surveyed sites and gained industrial knowledge. During his internship, he demonstrated his skills with self-motivation to learn new skills. His performance exceeded our expectations, and he was able to complete the project on time.

We wish him all the best for his upcoming career.

HRS ELECTRIC

PROPRIETOR

HRS Enterprises

Rampal Shukla

Manager

HRS

HRS ENTERPRISES

Specialist in electrical construction and installation works.

Address: Banda Nawaz Nagar, Plot no. 124, Gall no. 10, Behind HNGC CancerHospital,
Nagpur 440026

Date: 30/09/2022

TO WHOMSOEVER IT MAY CONCERN

This is to certify that **Jayush Patle** has done his internship in HRS Enterprises, Nagpur, from 20th July 2022 to 22nd August 2022. As part of the project, he has surveyed sites and gained industrial knowledge. During his internship, he demonstrated his skills with self-motivation to learn new skills. His performance exceeded our expectations, and he was able to complete the project on time.

We wish him all the best for his upcoming career.

HRS ELECTRIC

PROPRIETOR

HRS Enterprises

Rampal Shukla

Manager



INDO GERMAN TOOL ROOM, AURANGABAD
(A Government of India Society, Ministry of MSME)
EXTENSION CENTRE - NAGPUR



IGTR/NGP/2022-23/ 42

Friday, September 23, 2022

TO WHOME SO EVER IT MAY CONCERN

This is to certify that the following 23 student of **S.B Jain Institute of Technology Management & Research**, Nagpur had successful completed 15 Days Value Added Training Program on Electrical CAD at MSME Technology Center, Indo German Tool Room, Aurangabad Extension Center, Nagpur from 23/08/22 to 09/09/2022.

For, MSME IGTR Aurangabad EC, Nagpur

I. Haque



Engineer(CAD/CAM)

Encl: List of Students

P-142, M.I.D.C. INDUSTRIAL AREA, HINGNA, NAGPUR – 440028 (M.S.) INDIA

Email : training_ngp@igtr-aur.org, Web-site : www.igtr-au.org

Phone : (07104)-297136, Mob. No. : 9075095552



INDO GERMAN TOOL ROOM, AURANGABAD
(A Government of India Society, Ministry of MSME)
EXTENSION CENTRE - NAGPUR



List of Students :

- | | | |
|----|-----|------------------------------|
| 1 | Mr. | YOGESH SHRIKRUSHNA HIRPURKAR |
| 2 | Ms. | BORKAR AMISHA RAJU |
| 3 | Mr. | GAIKWAD MAYUR KISNA |
| 4 | Mr. | GOSWAMI ANKIT RAVI |
| 5 | Ms. | SHENDE KAJAL PRABHAKAR |
| 6 | Ms. | MESHRAM SIYA CHARANDAS |
| 7 | Mr. | MANWATKAR AMOGH ANIL |
| 8 | Mr. | KAPSE AYUSH POONAMCHAND |
| 09 | Mr. | KHOBRAGADE RUPESH RAJENDRA |
| 10 | Ms. | SHENDE VIDHISHA MAHENDRA |
| 11 | Mr. | SAKHARE SHIMON SUDHIR |
| 12 | Mr. | BHAISARE KARAN SUDHIR |
| 13 | Mr. | GAJBHIYE CHETAN VINOD |
| 14 | Ms. | SOMKUWAR SNEHA KAILAS |
| 15 | Mr. | GAJBHIYE PRATHAMESH PRAMOD |
| 16 | Ms. | JAMBHULKAR BHAVINA MORESHWAR |
| 17 | Mr. | BADAL PAGARE |
| 18 | Ms. | LANJEWAR GUNJAN MAROTI |
| 19 | Ms. | BANSOD DHANSHRI ARJUN |
| 20 | Mr. | SHENDE PRAFUL DILIP |
| 21 | Mr. | PIYUSH K TEMBHEKEAR |
| 22 | Mr. | DANDALE KAPIL GEMRAJ |
| 23 | Mr. | RANGARI SHREYASH MANOJ |



P-142, M.I.D.C. INDUSTRIAL AREA, HINGNA, NAGPUR – 440028 (M.S.) INDIA

Email : training_ngp@igtr-aur.org, Web-site : www.igtr-au.org

Phone : (07104)-297136, Mob. No. : 9225932264



INDO GERMAN TOOL ROOM, AURANGABAD
(A Government of India Society, Ministry of MSME)
EXTENSION CENTRE - NAGPUR



Ref. No.: MSME- TR/NGP/Trg./2022-23/ 52

Friday, September 23, 2022

TO WHOM SO EVER IT MAY CONCERN

This is to certify that Ms. SHEFALI BHALERAO had successfully completed Industrial Internship at our organisation MSME Technology Centre, Indo German Tool Room Aurangabad, Extension Centre Nagpur, from 23-08-22 to 09-09-2022.

For MSME Technology centre, IGTR Nagpur

Imranul Haque

Engineer (CAD/CAM)

P-142, M.I.D.C. INDUSTRIAL AREA, HINGNA, NAGPUR – 440028 (M.S.) INDIA

Email : training_ngp@igtr-aur.org, Web-site : www.igtr-au.org

Phone : (07104)-297136, Mob. No. : 9075095552

Shree Sai Rewinding And Electrical
Nagpur
certificate



Certified that Mr./Mrs./Kum. Yash S. Jekade

Which is B.E/B.TECH/Polytechnic branch Electrical Sem 4th

Name of the Institute S.B. Jain Institute of Technology

Has received training from 05/09/22 to 19/9/22

his discipline and eagerness towards training during is commendable.

Sequence:- 2202

Paper number:

Dated: 14/09/22

Signature of Senior Division

Jekade

श्री साई रिवाइंडिंग वर्क्स
नु मानकापुर, नागपूर-३०

Shree Sai Rewinding And Electrical

Nagpur

certificate



Certified that Mr./Mrs./Kum. Mohit S. Sorde

Which is B.E/B.TECH/Polytechnic branch Electrical Sem 4th

Name of the Institute S.B Jain Institute of Technology

Has received training from 05/09/22 to 19/09/22

his discipline and eagerness towards training during is commendable.

Sequence:- 2201

Paper number:

Dated: 14/09/22

Signature of Senior Division

श्री साई रिवाइंडिंग वर्क्स
नु धानकापुर, नागपूर-३०

Days Rewinding And Electrical
Nagpur
Certificate

Reg No:-2152300314990086

Certificate that Mr./Mrs./Kum. :- Yash .S. Chandekar

Which is B.E/B.TECH/Poytechnic branch Electrical Sem 4th

Name of the Institute :- S . B. Jain Institute of Technology

Has received training from 05/09/2022 to- 19/09/2022

His discipline and eagerness towards training during is commendable.

Sequence:- 2201

Paper number:-

Date:- 14/09/2022

Signature of Senior Division



Days Electrical
Old Bagadaganj, Nagpur- 440008
Mo. 9764593484



(Subject to Nagpur Jurisdiction)

BAJAJ STEEL INDUSTRIES LIMITED

C- 108, MIDC INDUSTRIAL AREA, HINGNA, NAGPUR - 440 028 (MS) INDIA Fax: +91 - 7104 - 237067
Tel.: +91 - 7104 238101 - 20 Email: - bsi@bajajngp.com, Website : www.bajajngp.com

CIN No. - L27100MH1961PLC011936



Date: 30th September 2022

CERTIFICATE

TO WHOMSOEVER IT MAY CONCERN

This is to certify that **Mr. Ulhas Munne** student of B.E. – Electrical Engineering (Fourth Semester), **S.B. Jain Institute of Technology, Management & Research, Nagpur** has completed Industrial Internship for **Fifteen days** in our Organization from **23rd August 2022 to 10th September 2022**. During this period he has studied various functions and working details of the Organization.

We wish him the best for his future endeavors.

For Bajaj Steel Industries Ltd.

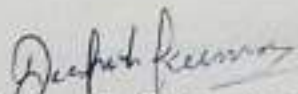
(Deepesh Srivastava)

Deputy GM (Electrical & PCI)

(Suneet Menon)

Sr. Manager (HR & IR)

DOLPHIN ELECTRONICS

C - 79, MIDC, Hingna, Nagpur 440 028.
email: dol.electronics@gmail.com

Ref: CT/021/22-23

Date: 11-SEPT-2022

TO WHOM IT MAY CONCERN

This is to certify that Mr. Subhash Pathak, student of 2nd Year (4th Semester) B. Tech in Electrical Engineering of SB Jain Institute of Technology Management & Research, Nagpur; has successfully completed 15 days internship (From 28th August to 11th Sept 2022) program at our Company.

During the period of his internship program with us he was found punctual, hardworking, and inquisitive.

We wish him every success in life.

For Dolphin Electronics,

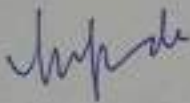

Authorized Signatory

DOLPHIN ELECTRONICS

C - 79, MIDC, Hingna, Nagpur 440 028.
email: dol.electronics@gmail.com

Ref: CT/021/22-23

Date: 11-SEPT-2022

TO WHOM IT MAY CONCERN

This is to certify that Mr. Sohail Sheikh, student of 2nd Year (4th Semester) B. Tech in Electrical Engineering of SB Jain Institute of Technology Management & Research, Nagpur; has successfully completed 15 days internship (From 28th August to 11th Sept 2022) program at our Company. During the period of his Internship program with us he was found punctual, hardworking, and inquisitive. We wish him every success in life.

For Dolphin Electronics,

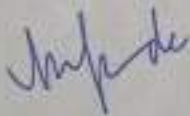

Authorized Signatory



DOLPHIN ELECTRONICS

C - 79, MIDC, Hingna, Nagpur 440 028.
email: dol.electronics@gmail.com

Ref: CT/021/22-23

Date: 11-SEPT-2022

TO WHOM IT MAY CONCERN

This is to certify that Mr. Kashaf Khan, student of 2nd Year (4th Semester) B. Tech in Electrical Engineering of SB Jain Institute of Technology Management & Research, Nagpur; has successfully completed 15 days internship (From 28th August to 11th Sept 2022) program at our Company.

During the period of his internship program with us he was found punctual, hardworking, and inquisitive.

We wish him every success in life.

For Dolphin Electronics

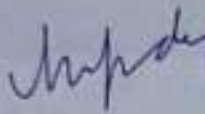

Authorized Signatory

27B0PPP0960N1Z7

INTERNSHIP CERTIFICATE

This is certify that **Ms. Rakhi Lohi**, student of **Bachelor of Technology in Electrical Engineering** from **S B Jain institute of technology, Nagpur** has successfully completed a summer 15 days internship from 24th August 2022 to 10th September 2022 as a trainee.

During the period of her internship program with us she had been exposed to different process was found punctual, hardworking and inquisitive.

We wish her every success in her life and carrier.

With Best Wishes,



Amit Kawle

Amit Kawle
Human Resource

Mahalaxmi Agro Energies

B 18/2, MIDC, Nagpur, Maharashtra - 441122

27B0PPP0960N1Z7

INTERNSHIP CERTIFICATE

This is certify that **Ms. Dipali Pathade**, student of **Bachelor of Technology in Electrical Engineering** from **S B Jain institute of technology, Nagpur** has successfully completed a summer 15 days internship from 24th August 2022 to 10th September 2022 as a trainee.

During the period of her internship program with us she had been exposed to different process was found punctual, hardworking and inquisitive.

We wish her every success in her life and carrier.

With Best Wishes,



Amit Kawle
Human Resource

Mahalaxmi Agro Energies

B 18/2, MIDC, Nagpur, Maharashtra - 441122

27B0PPP0960N1Z7

INTERNSHIP CERTIFICATE

This is certify that **Mr. Roshan Kolhe**, student of **Bachelor of Technology in Electrical Engineering** from **S B Jain institute of technology, Nagpur** has successfully completed a summer 15 days internship from 24th August 2022 to 10th September 2022 as a trainee.

During the period of his internship program with us he had been exposed to different process was found punctual, hardworking and inquisitive.

We wish him every success in his life and carrier.

With Best Wishes,

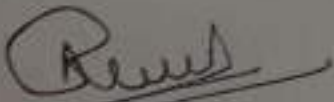

Amit Kawle
Human Resource

Mahalaxmi Agro Energies

B 18/2, MIDC, Nagpur, Maharashtra - 441122

PSV ENERGY SYSTEMS & SERVICES LLP

*Designer & Manufacturer
of Electric Control Panel*

EL-33, MIDC Hingana, Nagpur - 440016
Tel : 07104-236289
Mob. : +91 9503010009, 9373861170
E-mail : automation@psvenergy.in,
info@psvenergy.in, sales@psvenergy.in

To Whom it may Concern

This is to certify that Ku. Nandini Mandavkar student of S.B JAIN INSTITUTE OF TECHNOLOGY MANAGEMENT & RESEARCH NAGPUR. has successfully completed 15 days (15 Days) i.e. from 24.08.22 to 12.09.22, internship in the field of Electrical Panel under guidance of Mr. Viabhav Urkude.

During the period of her internship program with us, she had been exposed to different processes and was found diligent, hardworking and inquisitive.

We wish her every success in her life and career.

For PSV Energy Systems & Services LLP

Authorised Signatory

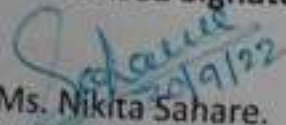
Ms. Nikita Sahare.
(Manager)



Raymond LIMITED

TEXTILE DIVISION

B-1, A.K.V.N. Kalesh Nagar, Sausar,
Chhindwara - 480106, Madhya Pradesh
Tel: (91-07165) 226503 / 226508
Fax: (91-07165) 226512

CIN: L17117MH1925PLC001208

RL/CHH/HR/2022/09
07/09/2022

TO WHOM SOEVER IT MAY CONCERN

*This is to certify that **Mr. Hitesh Dudhe**, a Student of **S. B. Jain Institute of Technology, Management & Research, Nagpur**, undergone Industrial training in our **Electrical Engineering Department** from **24/08/2022** to **07/09/2022**.*

He was sincere, hard working and punctual to the best of our knowledge.

We wish him all success in his future career.

FOR RAYMOND LIMITED
(Textile Division - Chhindwara)

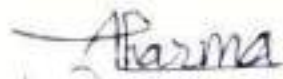

ASHISH SHARMA
EXECUTIVE - HR&ADMN.



OFFICE
165, Rawvidyanath Tagore Marg,
Civil Lines, Nagpur - 440 001, India
Tel: (0712) 2535003, 2542465
Fax: (0712) 2527162

REGISTERED OFFICE
Plot No. 156/H No. 2, Village Zedgaon,
Ratnagin - 415 517, Maharashtra
Tel: (02352) 232514
Fax: (02352) 232513



TEXTILE DIVISION

B 1, A, K, V, N, Kalash Nagar, Sadash
Chhindwara - 480106, Madhya Pradesh
Tel: (91-27185) 226503 - 226508
Fax: (91-07185) 226512

CIN: L17117MH1925PLC00120E

RL/CHH/HR/2022/09
07/09/2022

TO WHOM SOEVER IT MAY CONCERN

*This is to certify that **Mr. Piyesh Pethe**, a Student of S. B. Jain Institute of Technology, Management & Research, Nagpur, undergone Industrial training in our Electrical Engineering Department from 24/08/2022 to 07/09/2022.*

He was sincere, hard working and punctual to the best of our knowledge.

We wish him all success in his future career.

FOR RAYMOND LIMITED
(Textile Division - Chhindwara)

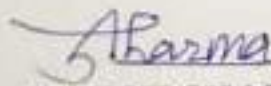
ASHISH SHARMA
EXECUTIVE - HR&ADMN.



OFFICE
165, Ravindranath Tagore Marg
Civil Lines, Nagpur - 440 001, India
Tel: (0712) 2535003, 2542465
Fax: (0712) 2527162

REGISTERED OFFICE
Plot No. 150/4 No. 2, Village Zadiagan
Ratnagiri - 415 512, Maharashtra
Tel: (02352) 232514
Fax: (02352) 232513

Raymond LIMITED

TEXTILE DIVISION

B-1, A.K.V.N. Kailash Nagar, Sausar
Chhindwara - 480126, Madhya Pradesh
Tel: (91-07195) 225503 / 225508
Fax: (91-07195) 225512

CIN: L17117MH1925PLC001208

RL/CHH/HR/2022/09
07/09/2022

TO WHOM SOEVER IT MAY CONCERN

This is to certify that Mr. Harshad Kale, a Student of S. B. Jain Institute of Technology, Management & Research, Nagpur, undergone Industrial training in our Electrical Engineering Department from 24/08/2022 to 07/09/2022.

He was sincere, hard working and punctual to the best of our knowledge.

We wish him all success in his future career.

FOR RAYMOND LIMITED
(Textile Division - Chhindwara)

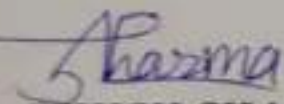
ASHISH SHARMA
EXECUTIVE - HR&ADMN.

OFFICE
185, Havindranath Tagore Marg,
Civil Lines, Nagpur - 440 001, India
Tel: (0712) 2535003, 2542465
Fax: (0712) 2527162

REGISTERED OFFICE
Plot No. 156/1 No. 2, Village Zadgaon,
Rajnagar - 415 612, Maharashtra
Tel: (02352) 232514
Fax: (02352) 232513



REDMI NOTE 8
AI QUAD CAMERA



Certificate of Internship

This is to certify that **Mr. Harshal Yuvraj Milmile**, a student of B.Tech Electrical Engineering, S.B. Jain Institute of Technology, Management and Research, Nagpur, Maharashtra has completed an internship program from 23rd Aug, 2022 to 08th Sep, 2022 at Saurabh Engineering Services, Nagpur under the guidance of Mr. M. Waqas Aamir. During the period of his internship program with us, he was found punctual, hardworking, and inquisitive. We wish him every success in life.

For Saurabh Engineering Services.



Authorized Signature

- Electrical Safety & Energy Auditors, Electrical Engineering Consultants
- Registered with MEDA, GEDA, HPCL, BPCL & IOCL

Off Add.: Shri Niwas Apartment, H.No. 569/11, Mukunraj Galli, Walker Road, Mahal, Nagpur-440032 (M.H.)

Email: saurabhese@gmail.com, sfbhattad@gmail.com, www.saurabhengineering.com

Ph. No.: 0712-2730112, Mob.:+91 9763190151, 7972427997, 7387470334



Certificate of Internship

This is to certify that **Mr. Harshal Gajanan Kohad**, a student of B.Tech Electrical Engineering, S.B. Jain Institute of Technology, Management and Research, Nagpur, Maharashtra has completed an internship program from 23rd Aug, 2022 to 08th Sep, 2022 at Saurabh Engineering Services, Nagpur under the guidance of Mr. M. Waqas Aamir. During the period of his internship program with us, he was found punctual, hardworking, and inquisitive. We wish him every success in life.

For Saurabh Engineering Services.



Authorized Signature

- Electrical Safety & Energy Auditors, Electrical Engineering Consultants
- Registered with MEDA, GEDA, HPCL, BPCL & IOCL

Off Add.: Shri Nilwas Appartment, H.No. 569/11, Mukunraj Galli, Walker Road, Mahal, Nagpur-440032 (M.H.)

Email: saurabhes@gmail.com, sdbhattad@gmail.com, www.saurabhengineering.com

Ph. No.: 0712-2730112, Mob.:+91 9763190151, 7972427997, 7387470334



Certificate of Internship

This is to certify that **Mr. Kartikeya Sunil Kewat**, a student of B.Tech Electrical Engineering, S.B. Jain Institute of Technology, Management and Research, Nagpur, Maharashtra has completed an internship program from 23rd Aug, 2022 to 08th Sep, 2022 at Saurabh Engineering Services, Nagpur under the guidance of Mr. M. Waqas Aamir. During the period of his internship program with us, he was found punctual, hardworking, and inquisitive. We wish him every success in life.

For Saurabh Engineering Services.



Authorized Signature



Certificate of Internship

This is to certify that Mr. Mohammad Jishan Shafi Shaikh, a student of B. Tech Electrical Engineering, S.B. Jain Institute of Technology, Management and Research, Nagpur, Maharashtra has completed an internship program from 23 Aug, 2022 to 08th Sep, 2022 at Saurabh Engineering Services, Nagpur under the guidance of Mr. M. Waqas Aamir. During the period of his internship program with us, he was found punctual, hardworking, and inquisitive. We wish him every Success in life.

For Saurabh Engineering Services.



Authorized Signature

- Electrical Safety, Energy Auditors & Electrical Engineering Consultants
- Registered with MEDA, PCRA, GEDA, HPCL, BPCL & IOCL

Off. Add: H.No.569/11, Shri Niwas Appartment, Mukunraj Galli, Walker Road, Mahal, Nagpur-440032 (M.H.)
Email: sesinfongp@gmail.com, sdbhattad@gmail.com | Website : www.saurabhengineering.com
Ph. No.: 0712-2730112, Mob.: 09763190151, 07972427997, 08626032960

Certificate of Training

Khushi Wasnik

from S.B.Jain Institute Of Technology, Management And Research has successfully completed an 8-week online training on **Web Development**. The training consisted of HTML, CSS, Bootstrap, DBMS, PHP, JS, React, and Final Project modules.

We wish Khushi all the best for future endeavours.



Sarvesh Agarwal

FOUNDER & CEO, INTERNSHALA

Date of certification: 2022-11-07

Certificate no. : 469899D4-BB7A-5363-1D75-83F483521FE3

For certificate authentication, please visit https://trainings.internshala.com/verify_certificate

Certificate of Training

Mohammad Shoab Sheikh

from S. B. Jain Institute Of Technology, Management & Research, Nagpur has successfully completed an 8-week online training on **Web Development**. The training consisted of HTML, CSS, Bootstrap, DBMS, PHP, JS, React, and Final Project modules.

Mohammad Shoab scored 100% marks in the final assessment and is a top performer in the training. We wish Mohammad Shoab all the best for future endeavours.

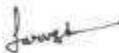

Sarvesh Agarwal

FOUNDER & CEO, INTERNSHALA

Date of certification: 2022-09-07

Certificate no.: AF65C76E-FCF3-F6D8-C851-BEF02A9F6754

For certificate authentication, please visit <https://trainings.internshala.com/verify/certificate>



Certificate of Completion

awarded to

Akshat Omprakash Agrawal

for successfully completing eight weeks internship under IBM SkillsBuild Program from
Aug 24, 2022 to Oct 12, 2022.

The program was conducted in collaboration with All India Council for Technical Education
and Edunet Foundation.

Nagesh Singh
Executive Director-
Edunet Foundation

Thirukumaran Nagarajan
VP HR- India and South Asia
IBM



Email : info@intechzia.com

Mob : 9579047478

Website : www.intechzia.com

Ref: INT/253/2022

Date: 28 / 09 / 2022

INTERNSHIP CERTIFICATE

This is to certify that **Miss Nidhi Deorao Shewale** a student of **7th SEM, ETC Branch, S.B. Jain Institute of Technology, Management and Research, Nagpur** has successfully completed **45 days Internship program on PYTHON** at **Intechzia, Nagpur**.

During the period of her internship program with us she was found punctual, hardworking and inquisitive. We wish her every success in life.

Regards,



Authorized signatory

Anup Khadakkar

Director

Intechzia



An ISO 9001:2015 Certified Company
ConnectSoft® InfoTech
Beyond the Success!

TO WHOM SO EVER IT MAY CONCERN

This is to certify that **Ms. Akanksha Sanjiv Ghorse** student of Electronics & telecommunication Engineering Department of S. B. Jain Institute of Technology, Management and Research, Nagpur, has undergoes Six Weeks Internship Training Program on **"Web Designing"** from August 8th, 2022 till September 27th, 2022 in our Organization, as a part of her academic curriculum.

During her training we found her to be sincere, hardworking and inquisitive.

We wish for her better career in future!

For ConnectSoft Infotech

A handwritten signature in blue ink, appearing to read 'Gunwant Mankar'.

Mr. Gunwant Mankar
Director





An ISO 9001:2015 Certified Company
ConnectSoft® InfoTech
Beyond the Success!

TO WHOM SO EVER IT MAY CONCERN

This is to certify that **Ms. Alisha Raut** student of Electronics & telecommunication Engineering Department of S. B. Jain Institute of Technology, Management and Research, Nagpur, has undergoes Six Weeks Internship Training Program on **"Web Designing"** from August 8th, 2022 till September 27th, 2022 in our Organization, as a part of her academic curriculum.

During her training we found her to be sincere, hardworking and inquisitive.

We wish for her better career in future!

For ConnectSoft Infotech

A handwritten signature in blue ink, appearing to read 'Gunwant Mankar'.

Mr. Gunwant Mankar
Director





An ISO 9001:2015 Certified Company

ConnectSoft® InfoTech

Beyond the Success!

TO WHOM SO EVER IT MAY CONCERN

This is to certify that **Ms. Anjali Hukumchand Mandlik** student of Electronics & telecommunication Engineering Department of S. B. Jain Institute of Technology, Management and Research, Nagpur, has undergoes Six Weeks Internship Training Program on "Web Designing" from August 8th, 2022 till September 27th, 2022 in our Organization, as a part of her academic curriculum.

During her training we found her to be sincere, hardworking and inquisitive.

We wish for her better career in future!

For ConnectSoft Infotech

A handwritten signature in blue ink, appearing to read 'Gunwant Mankar'.

Mr. Gunwant Mankar

Director





An ISO 9001:2015 Certified Company
ConnectSoft® InfoTech
Beyond the Success!

TO WHOM SO EVER IT MAY CONCERN

This is to certify that **Ms. Kanaklata Santosh Lakkawar** student of Electronics & telecommunication Engineering Department of S. B. Jain Institute of Technology, Management and Research, Nagpur, has undergoes Six Weeks Internship Training Program on **"Web Designing"** from August 8th, 2022 till September 27th, 2022 in our Organization, as a part of her academic curriculum.

During her training we found her to be sincere, hardworking and inquisitive.

We wish for her better career in future!

For ConnectSoft Infotech

A handwritten signature in blue ink that reads 'Gunwant Mankar'.

Mr. Gunwant Mankar
Director





An ISO 9001:2015 Certified Company

ConnectSoft® InfoTech

Beyond the Success!

TO WHOM SO EVER IT MAY CONCERN

This is to certify that **Ms. Khushi Tekade** student of Electronics & telecommunication Engineering Department of S. B. Jain Institute of Technology, Management and Research, Nagpur, has undergoes Six Weeks Internship Training Program on "**Web Designing**" from August 8th, 2022 till September 27th, 2022 in our Organization, as a part of her academic curriculum.

During her training we found her to be sincere, hardworking and inquisitive.

We wish for her better career in future!

For ConnectSoft Infotech

Mr. Gunwant Mankar
Director





An ISO 9001:2015 Certified Company
ConnectSoft® InfoTech
Beyond the Success!

TO WHOM SO EVER IT MAY CONCERN

This is to certify that **Ms. Mahevish Jamil Ahmed** student of Electronics & telecommunication Engineering Department of S. B. Jain Institute of Technology, Management and Research, Nagpur, has undergoes Six Weeks Internship Training Program on **"Web Designing"** from August 8th, 2022 till September 27th, 2022 in our Organization, as a part of her academic curriculum.

During her training we found her to be sincere, hardworking and inquisitive.

We wish for her better career in future!

For ConnectSoft Infotech

Mr. Gunwant Mankar
Director





An ISO 9001:2015 Certified Company
ConnectSoft® InfoTech
Beyond the Success!

TO WHOM SO EVER IT MAY CONCERN

This is to certify that Ms. Payal Vijay Gujar student of Electronics & telecommunication Engineering Department of S. B. Jain Institute of Technology, Management and Research, Nagpur, has undergoes Six Weeks Internship Training Program on "Web Designing" from August 8th, 2022 till September 27th, 2022 in our Organization, as a part of her academic curriculum.

During her training we found her to be sincere, hardworking and inquisitive.

We wish for her better career in future!

For ConnectSoft Infotech

A handwritten signature in blue ink, appearing to read 'Gunwant Mankar'.

Mr. Gunwant Mankar
Director





An ISO 9001:2015 Certified Company
ConnectSoft® InfoTech
Beyond the Success!

TO WHOM SO EVER IT MAY CONCERN

This is to certify that **Ms. Rijul Chandel** student of Electronics & telecommunication Engineering Department of S. B. Jain Institute of Technology, Management and Research, Nagpur, has undergoes Six Weeks Internship Training Program on "**Web Designing**" from August 8th, 2022 till September 27th, 2022 in our Organization, as a part of her academic curriculum.

During her training we found her to be sincere, hardworking and inquisitive.

We wish for her better career in future!

For ConnectSoft Infotech

Mr. Gunwant Mankar
Director





An ISO 9001:2015 Certified Company

ConnectSoft® InfoTech

Beyond the Success!

TO WHOM SO EVER IT MAY CONCERN

This is to certify that **Ms. Samiksha Sandesh Patil** student of Electronics & telecommunication Engineering Department of S. B. Jain Institute of Technology, Management and Research, Nagpur, has undergoes Six Weeks Internship Training Program on **"Web Designing"** from August 8th, 2022 till September 27th, 2022 in our Organization, as a part of her academic curriculum.

During her training we found her to be sincere, hardworking and inquisitive.

We wish for her better career in future!

For ConnectSoft Infotech

A handwritten signature in blue ink, appearing to read 'Gunwant Mankar'.

Mr. Gunwant Mankar
Director





An ISO 9001:2015 Certified Company
ConnectSoft® InfoTech
Beyond the Success!

TO WHOM SO EVER IT MAY CONCERN

This is to certify that **Ms. Shrutika Vijayraoji Dhote** student of Electronics & telecommunication Engineering Department of S. B. Jain Institute of Technology, Management and Research, Nagpur, has undergoes Six Weeks Internship Training Program on **"Web Designing"** from August 8th, 2022 till September 27th, 2022 in our Organization, as a part of her academic curriculum.

During her training we found her to be sincere, hardworking and inquisitive.

We wish for her better career in future!

For ConnectSoft Infotech

A handwritten signature in blue ink that reads 'Gunwant Mankar'.

Mr. Gunwant Mankar
Director





An ISO 9001:2015 Certified Company

ConnectSoft® InfoTech

Beyond the Success!

TO WHOM SO EVER IT MAY CONCERN

This is to certify that **Mr. Taslim Khan** student of Electronics & telecommunication Engineering Department of S. B. Jain Institute of Technology, Management and Research, Nagpur, has undergoes Six Weeks Internship Training Program on “**Web Designing**” from August 8th, 2022 till September 27th, 2022 in our Organization, as a part of his academic curriculum.

During his training we found him to be sincere, hardworking and inquisitive.

We wish for his better career in future!

For ConnectSoft Infotech

A handwritten signature in blue ink, appearing to read 'Gunwant Mankar'.

Mr. Gunwant Mankar

Director





An ISO 9001:2015 Certified Company

ConnectSoft® InfoTech

Beyond the Success!

TO WHOM SO EVER IT MAY CONCERN

This is to certify that **Mr. Aman N. Jamaiwar** student of Electronics & telecommunication Engineering Department of S. B. Jain Institute of Technology, Management and Research, Nagpur, has undergoes Six Weeks Internship Training Program on **"Web Designing"** from August 8th, 2022 till September 27th, 2022 in our Organization, as a part of his academic curriculum.

During his training we found him to be sincere, hardworking and inquisitive.

We wish for his better career in future!

For ConnectSoft Infotech

A handwritten signature in blue ink that reads 'Gunwant Mankar'.

Mr. Gunwant Mankar
Director





An ISO 9001:2015 Certified Company
ConnectSoft® InfoTech
Beyond the Success!

TO WHOM SO EVER IT MAY CONCERN

This is to certify that **Ms. Anchal Polade** student of Electronics & telecommunication Engineering Department of S. B. Jain Institute of Technology, Management and Research, Nagpur, has undergoes Six Weeks Internship Training Program on "Web Designing" from August 8th, 2022 till September 27th, 2022 in our Organization, as a part of her academic curriculum.

During her training we found her to be sincere, hardworking and inquisitive.

We wish for her better career in future!

For ConnectSoft Infotech

Mr. Gunwant Mankar
Director





An ISO 9001:2015 Certified Company
ConnectSoft® InfoTech
Beyond the Success!

TO WHOM SO EVER IT MAY CONCERN

This is to certify that **Ms. Bhagyashree Satpute** student of Electronics & telecommunication Engineering Department of S. B. Jain Institute of Technology, Management and Research, Nagpur, has undergoes Six Weeks Internship Training Program on "**Web Designing**" from August 8th, 2022 till September 27th, 2022 in our Organization, as a part of her academic curriculum.

During her training we found her to be sincere, hardworking and inquisitive.

We wish for her better career in future!

For ConnectSoft Infotech

A handwritten signature in blue ink, appearing to read 'Gunwant Mankar'.

Mr. Gunwant Mankar
Director





An ISO 9001:2015 Certified Company
ConnectSoft® InfoTech
Beyond the Success!

TO WHOM SO EVER IT MAY CONCERN

This is to certify that **Ms. Gayatri Kamal Dhakate** student of Electronics & telecommunication Engineering Department of S. B. Jain Institute of Technology, Management and Research, Nagpur, has undergoes Six Weeks Internship Training Program on **"Web Designing"** from August 8th, 2022 till September 27th, 2022 in our Organization, as a part of her academic curriculum.

During her training we found her to be sincere, hardworking and inquisitive.

We wish for her better career in future!

For ConnectSoft Infotech

A handwritten signature in blue ink, appearing to read 'Gunwant Mankar'.

Mr. Gunwant Mankar
Director





An ISO 9001:2015 Certified Company
ConnectSoft® InfoTech
Beyond the Success!

TO WHOM SO EVER IT MAY CONCERN

This is to certify that **Ms. Hemlata Pradip Rahangdale** student of Electronics & telecommunication Engineering Department of S. B. Jain Institute of Technology, Management and Research, Nagpur, has undergoes Six Weeks Internship Training Program on **"Web Designing"** from August 8th, 2022 till September 27th, 2022 in our Organization, as a part of her academic curriculum.

During her training we found her to be sincere, hardworking and inquisitive.

We wish for her better career in future!

For ConnectSoft Infotech

Mr. Gunwant Mankar
Director





An ISO 9001:2015 Certified Company

ConnectSoft® InfoTech

Beyond the Success!

TO WHOM SO EVER IT MAY CONCERN

This is to certify that **Ms. Monika Namdev khubalkar** student of Electronics & telecommunication Engineering Department of S. B. Jain Institute of Technology, Management and Research, Nagpur, has undergoes Six Weeks Internship Training Program on **"Web Designing"** from August 8th, 2022 till September 27th, 2022 in our Organization, as a part of her academic curriculum.

During her training we found her to be sincere, hardworking and inquisitive.

We wish for her better career in future!

For ConnectSoft Infotech

Mr. Gunwant Mankar
Director





An ISO 9001:2015 Certified Company
ConnectSoft® InfoTech
Beyond the Success!

TO WHOM SO EVER IT MAY CONCERN

This is to certify that **Ms. Neeshi Mohanlal Sahu** student of Electronics & telecommunication Engineering Department of S. B. Jain Institute of Technology, Management and Research, Nagpur, has undergoes Six Weeks Internship Training Program on **"Web Designing"** from August 8th, 2022 till September 27th, 2022 in our Organization, as a part of her academic curriculum.

During her training we found her to be sincere, hardworking and inquisitive.

We wish for her better career in future!

For ConnectSoft Infotech

A handwritten signature in blue ink, appearing to read 'Gunwant Mankar'.

Mr. Gunwant Mankar
Director





An ISO 9001:2015 Certified Company
ConnectSoft® InfoTech
Beyond the Success!

TO WHOM SO EVER IT MAY CONCERN

This is to certify that **Ms. Nancy Narendra Deshpande** student of Electronics & telecommunication Engineering Department of S. B. Jain Institute of Technology, Management and Research, Nagpur, has undergoes Six Weeks Internship Training Program on **"Web Designing"** from August 8th, 2022 till September 27th, 2022 in our Organization, as a part of her academic curriculum.

During her training we found her to be sincere, hardworking and inquisitive.

We wish for her better career in future!

For ConnectSoft Infotech

A handwritten signature in blue ink, appearing to read 'Gunwant Mankar'.

Mr. Gunwant Mankar
Director





An ISO 9001:2015 Certified Company
ConnectSoft® InfoTech
Beyond the Success!

TO WHOM SO EVER IT MAY CONCERN

This is to certify that **Ms. Nidhi Wankhade** student of Electronics & telecommunication Engineering Department of S. B. Jain Institute of Technology, Management and Research, Nagpur, has undergoes Six Weeks Internship Training Program on "**Web Designing**" from August 8th, 2022 till September 27th, 2022 in our Organization, as a part of her academic curriculum.

During her training we found her to be sincere, hardworking and inquisitive.

We wish for her better career in future!

For ConnectSoft Infotech

A handwritten signature in blue ink, appearing to read 'Gunwant Mankar'.

Mr. Gunwant Mankar
Director





An ISO 9001:2015 Certified Company

ConnectSoft® InfoTech

Beyond the Success!

TO WHOM SO EVER IT MAY CONCERN

This is to certify that **Ms. Papita Thakre** student of Electronics & telecommunication Engineering Department of S. B. Jain Institute of Technology, Management and Research, Nagpur, has undergoes Six Weeks Internship Training Program on "Web Designing" from August 8th, 2022 till September 27th, 2022 in our Organization, as a part of her academic curriculum.

During her training we found her to be sincere, hardworking and inquisitive.

We wish for her better career in future!

For ConnectSoft Infotech

Mr. Gunwant Mankar
Director





An ISO 9001:2015 Certified Company

ConnectSoft® InfoTech

Beyond the Success!

TO WHOM SO EVER IT MAY CONCERN

This is to certify that **Ms. Pranali Borkar** student of Electronics & telecommunication Engineering Department of S. B. Jain Institute of Technology, Management and Research, Nagpur, has undergoes Six Weeks Internship Training Program on "**Web Designing**" from August 8th, 2022 till September 27th, 2022 in our Organization, as a part of her academic curriculum.

During her training we found her to be sincere, hardworking and inquisitive.

We wish for her better career in future!

For ConnectSoft Infotech

A handwritten signature in blue ink, appearing to read 'Gunwant Mankar'.

Mr. Gunwant Mankar
Director





An ISO 9001:2015 Certified Company
ConnectSoft® InfoTech
Beyond the Success!

TO WHOM SO EVER IT MAY CONCERN

This is to certify that **Ms. Vaishnavi Srimanthula** student of Electronics & telecommunication Engineering Department of S. B. Jain Institute of Technology, Management and Research, Nagpur, has undergoes Six Weeks Internship Training Program on "**Web Designing**" from August 8th, 2022 till September 27th, 2022 in our Organization, as a part of her academic curriculum.

During her training we found her to be sincere, hardworking and inquisitive.

We wish for her better career in future!

For ConnectSoft Infotech

A handwritten signature in blue ink that reads 'Gunwant Mankar'.

Mr. Gunwant Mankar
Director





An ISO 9001:2015 Certified Company
ConnectSoft® InfoTech
Beyond the Success!

TO WHOM SO EVER IT MAY CONCERN

This is to certify that **Ms. Vanshika Ishwar Moundekar** student of Electronics & telecommunication Engineering Department of S. B. Jain Institute of Technology, Management and Research, Nagpur, has undergoes Six Weeks Internship Training Program on "Web Designing" from August 8th, 2022 till September 27th, 2022 in our Organization, as a part of her academic curriculum.

During her training we found her to be sincere, hardworking and inquisitive.

We wish for her better career in future!

For ConnectSoft Infotech

Mr. Gunwant Mankar
Director





An ISO 9001:2015 Certified Company

ConnectSoft® InfoTech

Beyond the Success!

TO WHOM SO EVER IT MAY CONCERN

This is to certify that **Mr. Adwait Abhay Borikar** student of Electronics & telecommunication Engineering Department of S. B. Jain Institute of Technology, Management and Research, Nagpur, has undergoes Six Weeks Internship Training Program on “**Web Designing**” from August 8th, 2022 till September 27th, 2022 in our Organization, as a part of his academic curriculum.

During his training we found him to be sincere, hardworking and inquisitive.

We wish for his better career in future!

For ConnectSoft Infotech

Mr. Gunwant Mankar
Director





An ISO 9001:2015 Certified Company

ConnectSoft® InfoTech

Beyond the Success!

TO WHOM SO EVER IT MAY CONCERN

This is to certify that **Mr. Ameya Makode** student of Electronics & telecommunication Engineering Department of S. B. Jain Institute of Technology, Management and Research, Nagpur, has undergoes Six Weeks Internship Training Program on "Web Designing" from August 8th, 2022 till September 27th, 2022 in our Organization, as a part of his academic curriculum.

During his training we found him to be sincere, hardworking and inquisitive.

We wish for his better career in future!

For ConnectSoft Infotech

A handwritten signature in blue ink, appearing to read 'Gunwant Mankar'.

Mr. Gunwant Mankar
Director





An ISO 9001:2015 Certified Company

ConnectSoft® InfoTech

Beyond the Success!

TO WHOM SO EVER IT MAY CONCERN

This is to certify that **Mr. Ashwin Kamble** student of Electronics & telecommunication Engineering Department of S. B. Jain Institute of Technology, Management and Research, Nagpur, has undergoes Six Weeks Internship Training Program on “**Web Designing**” from August 8th, 2022 till September 27th, 2022 in our Organization, as a part of his academic curriculum.

During his training we found him to be sincere, hardworking and inquisitive.

We wish for his better career in future!

For ConnectSoft Infotech

A handwritten signature in blue ink, appearing to read 'Gunwant Mankar'.

Mr. Gunwant Mankar
Director





An ISO 9001:2015 Certified Company
ConnectSoft® InfoTech
Beyond the Success!

TO WHOM SO EVER IT MAY CONCERN

This is to certify that **Mr. Gaurav Rewaskar** student of Electronics & telecommunication Engineering Department of S. B. Jain Institute of Technology, Management and Research, Nagpur, has undergoes Six Weeks Internship Training Program on "**Web Designing**" from August 8th, 2022 till September 27th, 2022 in our Organization, as a part of his academic curriculum.

During his training we found him to be sincere, hardworking and inquisitive.

We wish for his better career in future!

For ConnectSoft Infotech

Mr. Gunwant Mankar
Director





An ISO 9001:2015 Certified Company
ConnectSoft® InfoTech
Beyond the Success!

TO WHOM SO EVER IT MAY CONCERN

This is to certify that **Mr. Harsh Moriya** student of Electronics & telecommunication Engineering Department of S. B. Jain Institute of Technology, Management and Research, Nagpur, has undergoes Six Weeks Internship Training Program on "**Web Designing**" from August 8th, 2022 till September 27th, 2022 in our Organization, as a part of his academic curriculum.

During his training we found him to be sincere, hardworking and inquisitive.

We wish for his better career in future!

For ConnectSoft Infotech

Mr. Gunwant Mankar
Director





An ISO 9001:2015 Certified Company
ConnectSoft® InfoTech
Beyond the Success!

TO WHOM SO EVER IT MAY CONCERN

This is to certify that **Mr. Harshal Bankar** student of Electronics & telecommunication Engineering Department of S. B. Jain Institute of Technology, Management and Research, Nagpur, has undergoes Six Weeks Internship Training Program on "**Web Designing**" from August 8th, 2022 till September 27th, 2022 in our Organization, as a part of his academic curriculum.

During his training we found him to be sincere, hardworking and inquisitive.

We wish for his better career in future!

For ConnectSoft Infotech

A handwritten signature in blue ink that reads 'Gunwant Mankar'.

Mr. Gunwant Mankar
Director





An ISO 9001:2015 Certified Company
ConnectSoft® InfoTech
Beyond the Success!

TO WHOM SO EVER IT MAY CONCERN

This is to certify that **Mr. Kaustubh Anjankar** student of Electronics & telecommunication Engineering Department of S. B. Jain Institute of Technology, Management and Research, Nagpur, has undergoes Six Weeks Internship Training Program on "**Web Designing**" from August 8th, 2022 till September 27th, 2022 in our Organization, as a part of his academic curriculum.

During his training we found him to be sincere, hardworking and inquisitive.

We wish for his better career in future!

For ConnectSoft Infotech

Mr. Gunwant Mankar
Director





An ISO 9001:2015 Certified Company
ConnectSoft® InfoTech
Beyond the Success!

TO WHOM SO EVER IT MAY CONCERN

This is to certify that **Mr. Madhur Kishor Motghare** student of Electronics & telecommunication Engineering Department of S. B. Jain Institute of Technology, Management and Research, Nagpur, has undergoes Six Weeks Internship Training Program on "**Web Designing**" from August 8th, 2022 till September 27th, 2022 in our Organization, as a part of his academic curriculum.

During his training we found him to be sincere, hardworking and inquisitive.

We wish for his better career in future!

For ConnectSoft Infotech

Mr. Gunwant Mankar
Director





An ISO 9001:2015 Certified Company
ConnectSoft® InfoTech
Beyond the Success!

TO WHOM SO EVER IT MAY CONCERN

This is to certify that **Mr. Mahesh Karsarpe** student of Electronics & telecommunication Engineering Department of S. B. Jain Institute of Technology, Management and Research, Nagpur, has undergoes Six Weeks Internship Training Program on **"Web Designing"** from August 8th, 2022 till September 27th, 2022 in our Organization, as a part of his academic curriculum.

During his training we found him to be sincere, hardworking and inquisitive.

We wish for his better career in future!

For ConnectSoft Infotech

Mr. Gunwant Mankar
Director





An ISO 9001:2015 Certified Company

ConnectSoft® InfoTech

Beyond the Success!

TO WHOM SO EVER IT MAY CONCERN

This is to certify that **Mr. Nihal Raju Zade** student of Electronics & telecommunication Engineering Department of S. B. Jain Institute of Technology, Management and Research, Nagpur, has undergoes Six Weeks Internship Training Program on "**Web Designing**" from August 8th, 2022 till September 27th, 2022 in our Organization, as a part of his academic curriculum.

During his training we found him to be sincere, hardworking and inquisitive.

We wish for his better career in future!

For ConnectSoft Infotech

Mr. Gunwant Mankar
Director





An ISO 9001:2015 Certified Company
ConnectSoft® InfoTech
Beyond the Success!

TO WHOM SO EVER IT MAY CONCERN

This is to certify that **Ms. Nirmal Nandakumar** student of Electronics & telecommunication Engineering Department of S. B. Jain Institute of Technology, Management and Research, Nagpur, has undergoes Six Weeks Internship Training Program on **"Web Designing"** from August 8th, 2022 till September 27th, 2022 in our Organization, as a part of her academic curriculum.

During her training we found her to be sincere, hardworking and inquisitive.

We wish for her better career in future!

For ConnectSoft Infotech

A handwritten signature in blue ink, appearing to read 'Gunwant Mankar'.

Mr. Gunwant Mankar
Director





An ISO 9001:2015 Certified Company
ConnectSoft® InfoTech
Beyond the Success!

TO WHOM SO EVER IT MAY CONCERN

This is to certify that **Mr. Nishant Srivastav** student of Electronics & telecommunication Engineering Department of S. B. Jain Institute of Technology, Management and Research, Nagpur, has undergoes Six Weeks Internship Training Program on "**Web Designing**" from August 8th, 2022 till September 27th, 2022 in our Organization, as a part of his academic curriculum.

During his training we found him to be sincere, hardworking and inquisitive.

We wish for his better career in future!

For ConnectSoft Infotech

Mr. Gunwant Mankar
Director





An ISO 9001:2015 Certified Company

ConnectSoft® InfoTech

Beyond the Success!

TO WHOM SO EVER IT MAY CONCERN

This is to certify that **Mr. Pankaj Parmtosh Singh** student of Electronics & telecommunication Engineering Department of S. B. Jain Institute of Technology, Management and Research, Nagpur, has undergoes Six Weeks Internship Training Program on "**Web Designing**" from August 8th, 2022 till September 27th, 2022 in our Organization, as a part of his academic curriculum.

During his training we found him to be sincere, hardworking and inquisitive.

We wish for his better career in future!

For ConnectSoft Infotech

Mr. Gunwant Mankar
Director





An ISO 9001:2015 Certified Company
ConnectSoft® InfoTech
Beyond the Success!

TO WHOM SO EVER IT MAY CONCERN

This is to certify that **Mr. Pranay Kamble** student of Electronics & telecommunication Engineering Department of S. B. Jain Institute of Technology, Management and Research, Nagpur, has undergoes Six Weeks Internship Training Program on "**Web Designing**" from August 8th, 2022 till September 27th, 2022 in our Organization, as a part of his academic curriculum.

During his training we found him to be sincere, hardworking and inquisitive.

We wish for his better career in future!

For ConnectSoft Infotech

Mr. Gunwant Mankar
Director





An ISO 9001:2015 Certified Company
ConnectSoft® InfoTech
Beyond the Success!

TO WHOM SO EVER IT MAY CONCERN

This is to certify that **Mr. Pratik Sahare** student of Electronics & telecommunication Engineering Department of S. B. Jain Institute of Technology, Management and Research, Nagpur, has undergoes Six Weeks Internship Training Program on **"Web Designing"** from August 8th, 2022 till September 27th, 2022 in our Organization, as a part of his academic curriculum.

During his training we found him to be sincere, hardworking and inquisitive.

We wish for his better career in future!

For ConnectSoft Infotech

A handwritten signature in blue ink, appearing to read 'Gunwant Mankar'.

Mr. Gunwant Mankar
Director





An ISO 9001:2015 Certified Company

ConnectSoft® InfoTech

Beyond the Success!

TO WHOM SO EVER IT MAY CONCERN

This is to certify that **Mr. Rupesh A Khaikar** student of Electronics & telecommunication Engineering Department of S. B. Jain Institute of Technology, Management and Research, Nagpur, has undergoes Six Weeks Internship Training Program on “**Web Designing**” from August 8th, 2022 till September 27th, 2022 in our Organization, as a part of his academic curriculum.

During his training we found him to be sincere, hardworking and inquisitive.

We wish for his better career in future!

For ConnectSoft Infotech

A handwritten signature in blue ink, appearing to read 'Gunwant Mankar'.

Mr. Gunwant Mankar
Director





An ISO 9001:2015 Certified Company

ConnectSoft® InfoTech

Beyond the Success!

TO WHOM SO EVER IT MAY CONCERN

This is to certify that **Mr. Siddhant Babarao Tapre** student of Electronics & telecommunication Engineering Department of S. B. Jain Institute of Technology, Management and Research, Nagpur, has undergoes Six Weeks Internship Training Program on **"Web Designing"** from August 8th, 2022 till September 27th, 2022 in our Organization, as a part of his academic curriculum.

During his training we found him to be sincere, hardworking and inquisitive.

We wish for his better career in future!

For ConnectSoft Infotech

A handwritten signature in blue ink, appearing to read 'Gunwant Mankar'.

Mr. Gunwant Mankar
Director





An ISO 9001:2015 Certified Company

ConnectSoft® InfoTech

Beyond the Success!

TO WHOM SO EVER IT MAY CONCERN

This is to certify that **Mr. Yash Hatekar** student of Electronics & telecommunication Engineering Department of S. B. Jain Institute of Technology, Management and Research, Nagpur, has undergoes Six Weeks Internship Training Program on "**Web Designing**" from August 8th, 2022 till September 27th, 2022 in our Organization, as a part of his academic curriculum.

During his training we found him to be sincere, hardworking and inquisitive.

We wish for his better career in future!

For ConnectSoft Infotech

Mr. Gunwant Mankar
Director



Supported by



In Collaboration with



Certificate of Completion

This is to certify that AKSHAY PATNE has successfully completed the **Google Supported Virtual Internship Program** on "**Android Basics in Kotlin**" Organised by SmartInternz in collaboration with AICTE during the period **August to September 2022.**

Issued on: October 17, 2022

Handwritten signature of Kat Kuan in black ink.

Kat Kuan
Developer Advocate
Google



Handwritten signature of Amarender Katkam in black ink.

Amarender Katkam
Founder & CEO
SmartBridge

Certificate of Training

Nogal Chandekar

from S. B. Jain Institute Of Technology, Management & Research, Nagpur has successfully completed a 6-week online training on **Core Java**. The training consisted of Getting Started with Java, Leveraging Basic Concepts, Object Oriented Programming, and Java App Development modules.

Nogal scored 100% marks in the final assessment and is a top performer in the training.

We wish Nogal all the best for future endeavours.



Sarvesh Agarwal

FOUNDER & CEO, INTERNSHALA

Date of certification: 2022-09-22

Certificate no. : 66F96667-9EFF-EB8B-E1E4-3812F51DC797

For certificate authentication, please visit https://trainings.internshala.com/verify_certificate

16-09-2022

Certificate and Letter of Recommendation

To Whomsoever It May Concern

This is to certify that Tejas Sakore has successfully completed an internship with OlfaMach Engineering Solutions Pvt. Ltd. from 14-06-22 till 16-09-22.

As a part of the project, he has gained knowledge and contributed to the following tasks:

1. Studied and carried out experimental work on various types of metal oxide sensors
2. Successfully conducted experiments on Arduino communication-based systems.
3. Developed a code to interface various modules such as IoT, temperature sensor, humidity and pressure sensor.
4. Designed a power supply module in Eagle software
5. Assisted in writing an IEEE conference paper based on the results obtained during his internship.

He is a sincere and hard-working person and has competence to complete the task at hand from start to end of the goal. We sincerely believe that he will be extremely good, embedded design engineer. His performance during the project was above expectations. We wish him all the best for his future endeavours.



Shreevallabh Chougankar

Chief Operating Officer



SOFTTRONIX

Minal Jivnapurkar

Juni Mangalwari, Telephone
Exchange Square,
Nagpur, Maharashtra

SUB: LETTER OF EXPERIENCE OF INTERNSHIP :-Java Intern

Dear,

Minal Jivnapurkar

I hereby certify that Minal Bablesh Jivnapurkar B.E. (Electronics and Tele-Communication) student of S.B. Jain Institute of Technology, Management & Research, Nagpur was employed as **Intern** with our company, during the period starting from **1st March 2022 to 2nd September 2022**.

Minal Jivnapurkar Started working with Softtronix Company as a trainee and with sincere efforts & excellent performance was moved to the position Java Intern and was officially employed as a full time employee. For Six months of working with us, she demonstrated as a diligent and truthful person, Her interpersonal skills are outstanding and she has been very helpful.

We wish her success in her future efforts.

Thanking you,

From Softtronix IT Solutions

SOFTTRONIX

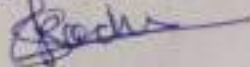
Proprietor

Signature with Name & Designation

Director / Manager – Human Resource

Address:- 2nd Floor Shravan Ganga Building ,Beside Jankidevi High School Main, Nandanvan Rd, Nagpur,
Maharashtra 440009

Contact:- 9168276045/ 9765073480, Email:-hr@softtronix.in, softtronix.ss@gmail.com

Website:- www.softtronix.in

SOFTTRONIX

Ms. Vaishnavi Dubbalwar

Juni Mangalwari, Telephone
Exchange Square, Nagpur, Maharashtra

SUB: LETTER OF EXPERIENCE OF INTERNSHIP:- Java Intern

Dear,
Ms. Vaishnavi

I hereby certify that Ms. Vaishnavi Ashok Dubbalwar B.E. (Electronics and Tele-Communication) student of S.B. Jain Institute of Technology, Management & Research, Nagpur was employed as **Intern** with our company, during the period starting from **1st March 2022 to 2nd September 2022**.

Ms. Vaishnavi Started working with Softtronix Company as a trainee and with sincere efforts & excellent performance was moved to the position **Java Intern** and was officially employed as a full time employee. For Six months of working with us, she demonstrated as a diligent and truthful person, Her interpersonal skills are outstanding and she has been very helpful.

We wish her success in her future efforts.

Thanking you,
From Softtronix IT Solutions

SOFTTRONIX

Proprietor

Signature with Name & Designation
Director / Manager – Human Resource

Address:- 2nd Floor Shraavan Ganga Building ,Beside Jankidevi High School Main, Nandanvan Rd, Nagpur,
Maharashtra 440009

Contact:- 9168276045/ 9765073480, Email:-hr@softtronix.in, softtronix.ss@gmail.com

Website:- www.softtronix.in

KRITIKA TECHNICAL ACADEMY

Technical Training Institute

Nagpur - 440013 Maharashtra (INDIA)



CERTIFICATE OF ACHIEVEMENT

Is awarded to Mr/Ms. SWAPNEEL S. ORAKEY

For successful completion of his/her internship course during

18/07/2022 - 20/08/2022

..... at small scale industries.

in Nagpur

Date of issue 01/09/2022

Er. VIJAY BHAMBRI
DIRECTOR



BSD MEP
BUILDING SERVICES DESIGN
MEP CONSULTANTS

"Suman" 158-B - Ground Floor

Hill Top, Ambazari - Nagpur 440010

Contact: 9970083027, 7447447030

Email bsdnep@gmail.com

Date: 30.09.2022

TO WHOMSOEVER IT MAY CONCERN

This is to certify that Mr. Tanishq S. Paraye Student of Mechanical Engineering from S.B. Jain Institute of technology Management & research , Nagpur has Completed Internship Successfully From 5th July 2022 to 5th August 2022 During this Period , he has shown good interest in the assignment works given to him and worked hard. During this tenure of internship, he was hard working and focused on activities assigned to him.

For,



BSD

Building Services Design

MEP Consultant



IGTR/NGP/2022-23/31

Saturday, August 6, 2022

CERTIFICATE

This is to certify that **Mr. BAGDE VAIBHAV VIKAS** student of S. B. Jain Institute of Technology, Management & Research Nagpur had successful completed Six Weeks **IN-PLANT TRAINING PROGRAM** at MSME Technology Center, Indo German Tool Room, Aurangabad Extension Center, Nagpur from 06/07/22 to 13/08/2022.

For, MSME IGTR Aurangabad EC, Nagpur

I. Haque

Engineer(CAD/CAM)





CERTIFICATE

INTERNSHIP & TRAINING PROGRAM

THIS CERTIFICATE PROUDLY PRESENTED TO

VAISHNAVI CHOURASIA

has successfully completed **Training + Internship of 'C, C++ & Data Structure Program'** from **August 2022 to September 2022** with extraordinary contribution, hard work & commitment.



A handwritten signature in black ink, appearing to be 'D.A.', written over a horizontal line.

DIRECTOR SIGNATURE

CERTIFICATE NUMBER: EDL-CI-490

SINGH ENGINEERING WORK
20/5 Near Kalya Machining
MIDC Wanadongri,
Hingna Road,
Nagpur-440028

Mob. No. 9372452865
Email Id. ramnathsingh.nagpur@gmail.com

PAN. No:-BLSPS6846N

Date:- Aug10, 2022.

This is to certify **Mr. Vedant Sudhir Kindar** student of **S. B. JAIN Institute of Technology, Management, and Research, Nagpur**, Branch of Mechanical Engineering has undergone 1-month of Summer Industrial Training in various sections of this organization **Singh Engineering Work** from 6/7/2022 to 10/8/2022

His performance during the above period has been found satisfactory

Yours faithfully,

For **Singh Engineering Work**

RAM NATH SINGH

(Authorized Signatory)

SINGH ENGINEERING WORK
P-20/5, M.I.D.C., Hingna
Nagpur



M.S.R.T. CORPORATION, BHANDARA DIVISION, BHANDARA
NATIONAL HIGHWAY-6 NAGPUR ROAD BHANDARA-441904



Phone No. 07184-252496, e-mail ; meo_stbhn@yahoo.com

No. ST/MEO/BHN/DWS/Training/2022-23/2151

Date:- 19-08-2022

TO WHOMSOEVER IT MAY CONCERN

This is to certify that Mr. Vishal Ramesh Chopkar student of S. B. Jain Institute of Technology, Management & Research, Nagpur has done his 1 Month internship/ industrial training at M.S.R.T. Corporation, Bhandara Division, Bhandara from 20 July 2022 to 19 August 2022.

During the period of his internship program with us, he had been exposed to different processes and was found punctual, hardworking, and inquisitive.

We wish him every success in his life and career.

Mechanical Engineer (OPN)
S. T. Bhandara

Mechanical Engineer
S.T. Bhandara



CERTIFICATE

INTERNSHIP & TRAINING PROGRAM

THIS CERTIFICATE PROUDLY PRESENTED TO:

VISHAL DHANWATEA

has successfully completed Training + Internship of 'C, C++ & Data Structure Program' from August 2022 to September 2022 with extraordinary contribution, hard work & commitment.



A handwritten signature in black ink, appearing to be 'V. Dhanwate'.

DIRECTOR SIGNATURE

CERTIFICATE NUMBER: EDL-CI-403

KRITIKA TECHNICAL ACADEMY

Technical Training Institute

Nagpur - 440013 Maharashtra (INDIA)



CERTIFICATE OF ACHIEVEMENT

Is awarded to Mr/Ms.VISHAL D. SHAHARE.....

For successful completion of his/her internship course during

.....15/07/2022 - 20/08/2022..... at small scale industries.
in Nagpur

Date of issue 01/09/2022

ER. VIJAY BHAMBRI
DIRECTOR



SIEMENS
Ingenuity for life



Visvesvaraya National Institute of Technology Nagpur

V. R. Jamdar Siemens Center of Excellence
Industry 4.0 & Digitalization

CERTIFICATE OF COURSE COMPLETION

This is to certify that

Vrushabh Bodhe

has successfully completed the Internship in

Smart Manufacturing

from 6th July , 2022 - 6th August , 2022

Director

Visvesvaraya National Institute of
Technology, Nagpur

Business Head

Business Head- federal &
Academics SIEMENS

Director

3D Engineering Automation LLP

Certificate ID- 3D_VRJSOE_00030

KRITIKA TECHNICAL ACADEMY

Technical Training Institute

Nagpur - 440013 Maharashtra (INDIA)



CERTIFICATE OF ACHIEVEMENT

Is awarded to Mr/Ms.MRUSHARH S. YESANSURE.....

For successful completion of his/her internship course during

.....15/07/2022 - 20/08/2022..... at small scale industries.
in Nagpur

Date of issue 01/09/2022

ER. VIJAY BHAMBRI
DIRECTOR



CERTIFICATE

INTERNSHIP & TRAINING PROGRAM

THIS CERTIFICATE PROUDLY PRESENTED TO:

YASH GHORPADE

has successfully completed Training + Internship of 'C, C++ & Data Structure Program' from August 2022 to September 2022 with extraordinary contribution, hard work & commitment.



A handwritten signature in black ink, appearing to be 'Yash Ghorpade', written over a horizontal line.

DIRECTOR SIGNATURE

CERTIFICATE NUMBER: EDL-CI-376

KEYANN ENGINEERING LLP

Off. Add.: 14, Sidhpura Co-op Industrial Estate, S.V. Road, Goregaon (W), Mumbai - 400062
Factory Add. : K-32/2, MIDC Hingna, Nagpur- 440016. Mob.: 07104 - 232316, 232317

Date : 16/08/22

Certificate

This is to certify that Mr. Yash Thakre student of Mechanical Engineering from S.B Jain Institute of technology management and research, Nagpur has completed Internship successfully from 14th July 2022 to 13th August 2022. During this period, he has shown good interest in the assignment/works given to him and worked hard. During his tenure of internship, he was hard working and focused on activities assigned to him.

Regards,

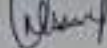
Signature - 

Name of HR Head - Mrs. Nikita V. Kamble

Designation - Plant Co-Ordinator

Industry Name & Address -

M/S. Keyann Engineering LLP

K32/2, MIDC, Hingna, Nagpur-16.





INDO GERMAN TOOL ROOM, AURANGABAD
(A Government of India Society, Ministry of MSME)
EXTENSION CENTRE - NAGPUR



IGTR/NGP/2022-23/ 34-

Saturday, August 6, 2022

CERTIFICATE

This is to certify that **Mr. GAJBHIYE AAYUSH ATTADIP** student of S. B. Jain Institute of Technology, Management & Research Nagpur had successful completed Six Weeks **IN-PLANT TRAINING PROGRAM** at MSME Technology Center, Indo German Tool Room, Aurangabad Extension Center, Nagpur from 06/07/22 to 13/08/2022.

For, MSME IGTR Aurangabad EC, Nagpur

I. Haque

Engineer(CAD/CAM)





CERTIFICATE

INTERNSHIP & TRAINING PROGRAM

THIS CERTIFICATE PROUDLY PRESENTED TO:

ABHISHEK KARMORE

has successfully completed Training + Internship of 'C, C++ & Data Structure Program' from August 2022 to September 2022 with extraordinary contribution, hard work & commitment.



A handwritten signature in black ink, appearing to be 'A. Karmore', written over a horizontal line.

DIRECTOR SIGNATURE

CERTIFICATE NUMBER: EDL-CI-363



दक्षिण पूर्व मध्य रेलवे
South East Central Railway
डीजल लोको शेड, मोतीबाग, नागपुर
Diesel Loco Shed Motibagh, Nagpur

75
आज़ादी का
अमृत महोत्सव

प्रमाणपत्र

प्रमाणित किया जाता है की एस. बी. जैन संस्थान ऑफ़ तकनीकी प्रबंधन तथा अनुसंधान, नागपुर, महाराष्ट्र के श्री आदेश कोल्हे ने 11.07.2022 से 10.08.2022 तक डीजल लोको शेड, मोतीबाग, दक्षिण पूर्व मध्य रेलवे, नागपुर, महाराष्ट्र में आयोजित भारतीय रेल के डीजल लोकोमोटिव पर इंटरनैशियल प्रशिक्षण पूरा किया है।

दिनांक: 15/09/2022

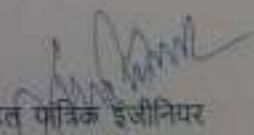
परिष्ठा मंडल पत्रिका इंजीनियर
द. पू. म. रेलवे, मोतीबाग, नागपुर
B. D. M. Railway, Motibagh, Nagpur
S. E. C. Railway, Motibagh, Nagpur



CERTIFICATE

INTERNSHIP & TRAINING PROGRAM

THIS CERTIFICATE PROUDLY PRESENTED TO:

ADITI ARUN KHOBRAGADE

has successfully completed Training + Internship of 'C, C++ & Data Structure Program' from August 2022 to September 2022 with extraordinary contribution, hard work & commitment.



A handwritten signature in black ink, appearing to be 'AD' followed by a horizontal line.

DIRECTOR SIGNATURE

CERTIFICATE NUMBER: EDL-CI-378



SIEMENS
Ingenuity for life



Visvesvaraya National Institute of Technology Nagpur

V. R. Jamdar Siemens Center of Excellence
Industry 4.0 & Digitalization

CERTIFICATE OF COURSE COMPLETION

This is to certify that

Aditya Vyapari

has successfully completed the Internship in

Smart Manufacturing

from 6th July , 2022 - 6th August , 2022

Director

Visvesvaraya National Institute of
Technology, Nagpur

Business Head

Business Head- federal &
Academics SIEMENS

Director

3D Engineering Automation LLP

Certificate ID- 3D_VRJSOE_00028



CERTIFICATE

INTERNSHIP & TRAINING PROGRAM

THIS CERTIFICATE PROUDLY PRESENTED TO

ADNAN HASSAN

has successfully completed **Training + Internship** of "**C, C++ & Data Structure Program**" from **August 2022 to September 2022** with extraordinary contribution, hard work & commitment.



A handwritten signature in black ink, appearing to be 'AD' followed by a horizontal line.

DIRECTOR SIGNATURE

CERTIFICATE NUMBER: EDL-CI-560

Certificate of Training

Akash Ratnakar Mahajan

from S. B. Jain Institute Of Technology, Management & Research, Nagpur has successfully completed an 8-week online training on **Web Development**. The training consisted of HTML, CSS, Bootstrap, DBMS, PHP, JS, React, and Final Project modules.

Akash Mahajan scored 98% marks in the final assessment and is a top performer in the training.
We wish Akash Mahajan all the best for future endeavours.

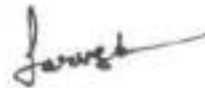

Sarvesh Agarwal

FOUNDER & CEO, INTERNSHALA

Date of certification: 2022-08-05

Certificate no.: 8A42A843-2ACE-B4ED-1EEE-F23D08D11823

For certificate authentication, please visit: https://trainings.internshala.com/verify_certificate



दक्षिण पूर्व मध्य रेलवे
South East Central Railway
डीजल लोको शेड, मोतीबाग, नागपुर
Diesel Loco Shed Motibagh, Nagpur

75
आज़ादी का
अमृत महोत्सव

प्रमाणपत्र

प्रमाणित किया जाता है की एस. बी. जेन संरक्षण और तकनीकी प्रबंधन तथा अनुसंधान, नागपुर, महाराष्ट्र के श्री अक्षय पाटील ने 11.07.2022 से 10.08.2022 तक डीजल लोको शेड, मोतीबाग, दक्षिण पूर्व मध्य रेलवे, नागपुर, महाराष्ट्र में आयोजित भारतीय रेल के डीजल लोकोमोटिव पर इंटरनैशनल प्रशिक्षण पूरा किया है।

दिनांक: _____

परिचय मंडल पत्रिका इंजीनियर
द. घु. म. रेलवे, मोतीबाग/नागपुर



दक्षिण पूर्व मध्य रेल्वे
South East Central Railway
डीजल लोको शेड, मोतीबाग, नागपुर
Diesel Loco Shed Motibagh, Nagpur

75
आज़ादी का
अमृत महोत्सव

प्रमाणपत्र

प्रमाणित किया जाता है की एस. बी. जैन संस्थान ऑफ़ तकनीकी प्रबंधन तथा अनुसंधान, नागपुर, महाराष्ट्र के श्री अमन कुरैशी ने 11.07.2022 से 10.08.2022 तक डीजल लोको शेड, मोतीबाग, दक्षिण पूर्व मध्य रेल्वे, नागपुर, महाराष्ट्र में आयोजित भारतीय रेल के डीजल लोकोमोटिव पर इंटर्नशिप प्रशिक्षण पूरा किया है।

दिनांक: 15.09.2022

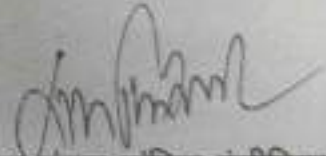
वरिष्ठ मंडल यांत्रिक इंजीनियर
द. पू. म. रेल्वे, मोतीबाग/ नागपुर
Dr. Dhr. Meeth. Singhania
द. पू. म. रेल्वे, मोतीबाग, नागपुर
S.E.C. Railway, Motibagh, Nagpur



SIEMENS
Ingenuity for life



Visvesvaraya National Institute of Technology Nagpur

V. R. Jamdar Siemens Center of Excellence
Industry 4.0 & Digitalization

CERTIFICATE OF COURSE COMPLETION

This is to certify that

Amey Dnyaneshwar Kohale

has successfully completed the Internship in

Smart Manufacturing

from 6th July , 2022 - 6th August , 2022

Director

Visvesvaraya National Institute of
Technology, Nagpur

Business Head

Business Head- federal &
Academics SIEMENS

Director

3D Engineering Automation LLP

Certificate ID- 3D_VRJSOE_00027

Certificate of Training

Aniket Supekar

from S. B. Jain Institute of Technology, Management & Research, Nagpur has successfully completed a 6-week online training on **Programming with Python**. The training consisted of Introduction to Python, Using Variables in Python, Basics of Programming in Python, Principles of Object-oriented Programming (OOP), Connecting to SQLite Database, Developing a GUI with PyQt, Application of Python in Various Disciplines, and The Final Project modules.

Aniket scored 100% marks in the final assessment and is a top performer in the training.

We wish Aniket all the best for future endeavours.



Sarvesh Agarwal

FOUNDER & CEO, INTERNSHALA

Date of certification: 2022-08-11

Certificate no. : 5994C398-47DE-F34D-BF78-2B26FE729390

For certificate authentication, please visit https://trainings.internshala.com/verify_certificate



दक्षिण पूर्व मध्य रेल्वे
South East Central Railway
डीजल लोको शेड, मोतीबाग, नागपुर
Diesel Loco Shed Motibagh, Nagpur

75
आज़ादी का
अमृत महोत्सव

प्रमाणपत्र

प्रमाणित किया जाता है की एस. बी. जैन संस्थान ऑफ तकनीकी प्रबंधन तथा अनुसंधान, नागपुर, महाराष्ट्र के श्री अनिकेत महादेव तावडे ने 11.07.2022 से 10.08.2022 तक डीजल लोको शेड, मोतीबाग, दक्षिण पूर्व मध्य रेल्वे, नागपुर, महाराष्ट्र में आयोजित भारतीय रेल के डीजल लोकोमोटिव पर इंटर्नशिप प्रशिक्षण पूरा किया है।

दिनांक: 15-09-2022

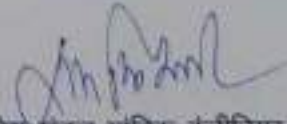
वरिष्ठ मंडल यांत्रिक इंजीनियर
द. पू. म. रेल्वे, मोतीबाग/नागपुर

वरिष्ठ मंडल यांत्रिक अभियंता
Sr. Div. Mech. Engineer
द. पू. म. रेल्वे, मोतीबाग, नागपुर
S.E.C. Railway, Motibagh, Nagpur



दक्षिण पूर्व मध्य रेल्वे
South East Central Railway
डीजल लोको शेड, मोतीबाग, नागपुर
Diesel Loco Shed Motibagh, Nagpur

75
आज़ादी का
अमृत महोत्सव

प्रमाणपत्र

प्रमाणित किया जाता है की एस. बी. जैन संस्थान ऑफ़ तकनीकी प्रबंधन तथा अनुसंधान, नागपुर, महाराष्ट्र के श्री अंकुश वाय. सिंधिधनसुरे ने 11.07.2022 से 10.08.2022 तक डीजल लोको शेड, मोतीबाग, दक्षिण पूर्व मध्य रेल्वे, नागपुर, महाराष्ट्र में आयोजित भारतीय रेल के डीजल लोकोमोटिव पर इंटरनेशनल प्रशिक्षण पूरा किया है।

दिनांक: 15-09-2022

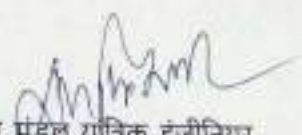
वरिष्ठ मंडल यांत्रिक इंजीनियर
द. पू. म. रेल्वे, मोतीबाग, नागपुर
वरिष्ठ मंडल यांत्रिक अभियंता
Dr. Dhanu Bhanu, Engineer
द.पु.म. रेलवे, मोतीबाग, नागपुर
S.E.C. Railway, Nagpur



दक्षिण पूर्व मध्य रेल्वे
South East Central Railway
डीजल लोको शेड, मोतीबाग, नागपुर
Diesel Loco Shed Motibagh, Nagpur

75
आजादी का
अमृत महोत्सव

प्रमाणपत्र

प्रमाणित किया जाता है की एस. बी. जैन संस्थान ऑफ तकनीकी प्रबंधन तथा अनुसंधान, नागपुर, महाराष्ट्र के श्री अश्विन कुंदावले ने 11.07.2022 से 10.08.2022 तक डीजल लोको शेड, मोतीबाग, दक्षिण पूर्व मध्य रेल्वे, नागपुर, महाराष्ट्र में आयोजित भारतीय रेल के डीजल लोकोमोटिव पर इंटर्नशिप प्रशिक्षण पूरा किया है।

दिनांक: 15-09-2022

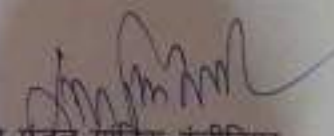
वरिष्ठ मंडल यांत्रिक इंजीनियर
द. पू. म. रेल्वे, मोतीबाग/नागपुर

दक्षिण पूर्व मध्य रेल्वे
Sr. Dir. Mech. Engineer
D.P.M. Shed, Motibagh, Nagpur
S.E.C. Railway Motibagh, Nagpur



SIEMENS
Ingenuity for life



Visvesvaraya National Institute of Technology Nagpur

V. R. Jamdar Siemens Center of Excellence
Industry 4.0 & Digitalization

CERTIFICATE OF COURSE COMPLETION

This is to certify that

Atharva Mahesh Raut

has successfully completed the Internship in

Smart Manufacturing

from 6th July , 2022 - 6th August , 2022

Director

Visvesvaraya National Institute of
Technology, Nagpur

Business Head

Business Head- federal &
Academics SIEMENS

Director

3D Engineering Automation LLP

Certificate ID- 3D_VRJSOE_00026

Certificate of Training

Bhimsen Baghele

from S. B. Jain Institute Of Technology, Management & Research, Nagpur has successfully completed an 8-week online training on **Programming with C and C++**. The training consisted of Getting Started With Programming in C, Diving Into C Programming, Fundamentals of Object Oriented Programming Using CPP, Diving into CPP Programming, and Building Cricket Game Application modules.

In the final assessment, Bhimsen scored 74% marks.

We wish Bhimsen all the best for future endeavours.



Sarvesh Agarwal

FOUNDER & CEO, INTERNSHALA

Date of certification: 2022-09-06

Certificate no. : 9F62502D-BA79-84EF-7ED6-0D8E67BBBEC9

For certificate authentication, please visit https://trainings.internshala.com/verify_certificate



INDO GERMAN TOOL ROOM, AURANGABAD
(A Government of India Society, Ministry of MSME)
EXTENSION CENTRE - NAGPUR



IGTR/NGP/2022-23/33

Saturday, August 6, 2022

CERTIFICATE

This is to certify that **Mr. BURDE BHUMIKA ABHAY** student of S. B. Jain Institute of Technology, Management & Research Nagpur had successful completed Six Weeks **IN-PLANT TRAINING PROGRAM** at MSME Technology Center, Indo German Tool Room, Aurangabad Extension Center, Nagpur from 06/07/22 to 13/08/2022.

For, MSME IGTR Aurangabad EC, Nagpur

I. Haque

Engineer(CAD/CAM)



P-142, M.I.D.C. INDUSTRIAL AREA, HINGNA, NAGPUR – 440028 (M.S.) INDIA

Email : training_ngp@igtr-aur.org, Web-site : www.igtr-au.org

Phone : (07104)-297136, Mob. No. : 9075095552



SIEMENS
Ingenuity for life



Visvesvaraya National Institute of Technology Nagpur

V. R. Jamdar Siemens Center of Excellence

Industry 4.0 & Digitalization

CERTIFICATE OF COURSE COMPLETION

This is to certify that

Chirag Ghanshyam Verma

has successfully completed the Internship in

Smart Manufacturing

from 6th July, 2022 - 6th August, 2022

Director

Visvesvaraya National Institute of
Technology, Nagpur

Business Head

Business Head- federal &
Academics SIEMENS

Director

3D Engineering Automation LLP

Certificate ID- 3D_VRJSOE_00025

TRAINING CERTIFICATE

This is to certify that **Mr. Damendrakumar K Bhagat**, student of **S.B Jain Institute of Technology, Management & Research** has completed his **1-month** internship with us, from **11th July, 2022 to 9th August, 2022**.

As part of the internship he has done a study in the department of **"Transmission Machining"** as **"Diploma Engineering Trainee"** employee.

During the tenure with us, we found **Mr. Damendrakumar K Bhagat**, sincere and result oriented.

For Mahindra & Mahindra Tractors Ltd.



Hemant Khumbhalkar

Transmission Machining Department - Line Head

GLOBAL ENGINEERING WORKS

At Site Address: Khardpur Crusher Area, Laxo Road, Wadi, Nagpur-441501, India.

☎ +918605478592, +919372007420
📍 Plot no. 10, Teko Naka, In Front of
Soyona Public School, Nagpur - 440017, India
✉ gewnagpur@gmail.com
🌐 www.gewnagpur.com

Date: 31 July, 2022

TO WHOMSOEVER IT MAY CONCERN

This is to certify that Mr. Danish Hussain Zakir Hussain has done his internship in Mechanical Engineer at Global Engineering Works, Nagpur 08th July 2022 to 31st July 2022.

During the internship he demonstrated good skills with a self-motivated attitude to learn new things. His performance exceeded expectations and was able to complete the project successfully on time.

We wish him all the best for his future endeavours.

For Global Engineering For Global Engineering Works
Project Manager  Proprietor

Signatures _____

KRITIKA TECHNICAL ACADEMY

Technical Training Institute

Nagpur - 440013 Maharashtra (INDIA)



CERTIFICATE OF ACHIEVEMENT

Is awarded to Mr/Ms. ...DEVAM D. KATHANE.....

For successful completion of his/her internship course during

.....15/07/2022 - 20/08/2022..... at small scale industries.
in Nagpur

Date of issue 01/09/2022

Er. VIJAY BHAMBRI
DIRECTOR



INTERNSHIP CERTIFICATE

This is to certify that **Mr. Devesh Avinash Ninave** student of **SB Jain College of Institute of Technology ,Management & Research Nagpur** have satisfactorily completed his Training (case studies with project submission) programme under **Manojyoti Infotech, Nagpur** on Solidworks and Catia software from 15th June to 15th August 2022.

A handwritten signature in black ink, appearing to read 'Swati'.

Swati Bhatia
Business Manager, Manojyoti Infotech



A handwritten signature in black ink, appearing to read 'Swapnil Udapurkar'.

Mr . Swapnil Udapurkar
Director , Manojyoti Infotech

ED/CRT/TA/23252953
August 10, 2022

TRAINING CERTIFICATE

This is to certify that Mr. Devyani Prakash Joshi has undergone practical training in Transmission Machining department of this organization, as Technician Apprentice from 10-Aug-2020 to 09-Aug-2021 under the Apprentices Act, 1961 and as a Technical Trainee from 10-Aug-2021 to 09-Aug-2022.

His last Stipend was Rs. 1.93 Lac per annum.

During the training period, his attendance and conduct were **Good**.

We wish him all success in his future assignments.

For Mahindra & Mahindra Ltd.

Yogesh Shukla
Manager - ER & D





दक्षिण पूर्व मध्य रेल्वे
South East Central Railway
डीजल लोको शेड, मोतीबाग, नागपुर
Diesel Loco Shed Motibagh, Nagpur

75
आज़ादी का
अमृत महोत्सव

प्रमाणपत्र

प्रमाणित किया जाता है की एस. बी. जैन संस्थान ऑफ तकनीकी प्रबंधन तथा अनुसंधान, नागपुर, महाराष्ट्र के श्री धीरज मूनडेकर ने 11.07.2022 से 10.08.2022 तक डीजल लोको शेड, मोतीबाग, दक्षिण पूर्व मध्य रेल्वे, नागपुर, महाराष्ट्र में आयोजित भारतीय रेल के डीजल लोकोमोटिव पर इंटर्नशिप प्रशिक्षण पूरा किया है।

दिनांक: 15.09.2022

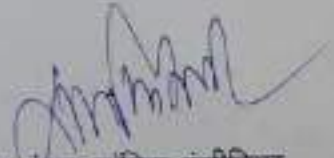
वरिष्ठ सेंट्रल यांत्रिक इंजीनियर
द. पू. म. रेल्वे, मोतीबाग/ नागपुर
Sr. Dtl. Mech. Engineer
द. पू. म. रेल्वे, मोतीबाग, नागपुर
S.E.C. Railway, Motibagh, Nagpur

TRAINING CERTIFICATE

This is to certify that **Mr. Dipaklal E Bisen**, student of **S.B Jain Institute of Technology, Management & Research** has completed his **1-month** internship with us, from **11th July, 2022 to 9th August, 2022**.

As part of the internship he has done a study in the department of **"Transmission Machining"** as **"Diploma Engineering Trainee"** employee.

During the tenure with us, we found **Mr. Diapaklal E Bisen**, sincere and result oriented.



For Mahindra & Mahindra Tractors Ltd.

A handwritten signature in blue ink, appearing to read "Hemant Khumbhalkar".

Hemant Khumbhalkar

Transmission Machining Department - Line Head



Gustovalley Technovations

CERTIFICATE OF COMPLETION

This Certifies that

Dipansh Ganpati Hirudkar

has successfully completed 'Gustovalley Technovations' Internship Training
Program on Industry 4.0

which was conducted from 01 AUG 2022 to 01 SEP 2022.

The Performance delivered during the program was Good

Authorized Signatory

Certificate No. : GL5101



INDO GERMAN TOOL ROOM, AURANGABAD
(A Government of India Society, Ministry of MSME)
EXTENSION CENTRE - NAGPUR



IGTR/NGP/2022-23/ 32

Saturday, August 6, 2022

CERTIFICATE

This is to certify that Mr. **DHOBAL GANESH MEGHRAJ** student of S. B. Jain Institute of Technology, Management & Research Nagpur had successful completed Six Weeks **IN-PLANT TRAINING PROGRAM** at MSME Technology Center, Indo German Tool Room, Aurangabad Extension Center, Nagpur from 06/07/22 to 13/08/2022.

For, MSME IGTR Aurangabad EC, Nagpur

I. Haque

Engineer(CAD/CAM)





M.S.R.T. CORPORATION, BHANDARA DIVISION, BHANDARA
NATIONAL HIGHWAY-6 NAGPUR ROAD BHANDARA-441904



Phone No. 07184-252496, e-mail ; meo_stbhn@yahoo.com

No. ST/MEO/BHN/DWS/Training/2022-23/2151

Date:- 19-08-2022

TO WHOMSOEVER IT MAY CONCERN

This is to certify that Mr. Gaurav Suresh Pardhi student of S. B. Jain Institute of Technology, Management & Research, Nagpur has done his 1 Month internship/ industrial training at M.S.R.T. Corporation, Bhandara Division, Bhandara from 20 July 2022 to 19 August 2022.

During the period of his internship program with us, he had been exposed to different processes and was found punctual, hardworking, and inquisitive.

We wish him every success in his life and career.

Mechanical Engineer (OPN)
S. T. Bhandara

Mechanical Engineer
S.T. Bhandara

ED/CRT/TA/23256806
September 27, 2022

TRAINING CERTIFICATE



This is to certify that Mr. Gopal Yogendrasingh Thakur has undergone practical training in Transmission Assembly department of this organization, as Technician Apprentice from 01-Mar-2020 to 28-Feb-2021 under the Apprentices Act, 1961 and as a Technical Trainee from 01-Mar-2021 to 15-Sep-2022.

His last Stipend was Rs. 1.93 Lac per annum.

During the training period, his attendance and conduct were Good.

We wish him all success in his future assignments.

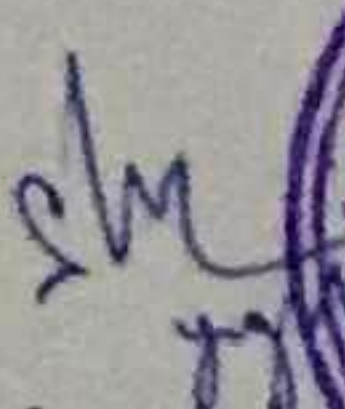
For Mahindra & Mahindra Ltd.



Yogesh Sharma
Manager - HRD

Certificate of Training

Harsh Balpande

from S. B. Jain Institute of Technology, Management & Research, Nagpur has successfully completed a 6-week online training on **Programming with Python**. The training consisted of Introduction to Python, Using Variables in Python, Basics of Programming in Python, Principles of Object-oriented Programming (OOP), Connecting to SQLite Database, Developing a GUI with PyQt, Application of Python in Various Disciplines, and The Final Project modules.

Harsh scored 98% marks in the final assessment and is a top performer in the training.
We wish Harsh all the best for future endeavours.



Sarvesh Agarwal

FOUNDER & CEO, INTERNSHALA

Date of certification: 2022-08-11

Certificate no. : ACD18354-F4FE-8158-EF6D-DC4E3BF0B603

For certificate authentication, please visit https://trainings.internshala.com/verify_certificate



Gajanan Enterprises

(ALL TYPES OF ELECTRICAL WORKS)

CERTIFICATE OF COMPLETION

This Certificate is awarded to

HARSH PAWAN JANBANDHU

*For successfully completing the Internship Program at the Gajanan Enterprises,
From 06 July 2022 to 06 August 2022. We appreciate your contribution and have
thoroughly enjoyed having you as an Intern at Gajanan Enterprises. We wish you
the best in your future endeavors.*

Gajanan Enterprises

Reg.No. : MT-34962

Plot No. 147, Samyak Nagar,

Nari Road, Nagpur-440026

Mob.No. 9923872275

Date of Certification :- 9th August, 2022

For Gajanan Enterprises

Proprietor

Founder

Gajanan Enterprises

KRITIKA TECHNICAL ACADEMY

Technical Training Institute

Nagpur - 440013 Maharashtra (INDIA)



CERTIFICATE OF ACHIEVEMENT

Is awarded to Mr/Ms. HARSH T. MANJARI

For successful completion of his/her internship course during

..... 15/07/2022 - 20/08/2022 at small scale industries.
in Nagpur

Date of issue 01/09/2022

ER. VIJAY BHAMBRI
DIRECTOR



CERTIFICATE

INTERNSHIP & TRAINING PROGRAM

THIS CERTIFICATE PROUDLY PRESENTED TO:

HARSHA PYARELAL BHAIRAM

has successfully completed Training + Internship of 'C, C++ & Data Structure Program' from August 2022 to September 2022 with extraordinary contribution, hard work & commitment.



A handwritten signature in black ink, appearing to be 'D.A.', written over a horizontal line.

DIRECTOR SIGNATURE

CERTIFICATE NUMBER: EDL-CI-375



दक्षिण पूर्व मध्य रेल्वे
South East Central Railway
डीजल लोको शेड, मोतीबाग, नागपुर
Diesel Loco Shed Motibagh, Nagpur

75
आजादी का
अमृत महोत्सव

प्रमाणपत्र

प्रमाणित किया जाता है की एस. बी. जैन संस्थान ऑफ़ तकनीकी प्रबंधन तथा अनुसंधान, नागपुर, महाराष्ट्र के श्री हर्षल मेश्राम ने 11.07.2022 से 10.08.2022 तक डीजल लोको शेड, मोतीबाग, दक्षिण पूर्व मध्य रेल्वे, नागपुर, महाराष्ट्र में आयोजित भारतीय रेल के डीजल लोकोमोटिव पर इंटरनशिप प्रशिक्षण पूरा किया है।

दिनांक: 15-09-2022

वरिष्ठ मंडल यांत्रिक इंजीनियर
द. पू. म. रेल्वे, मोतीबाग/नागपुर
रॉड नंबर 10, मोतीबाग, नागपुर
पिन कोड: 481001, नागपुर



दक्षिण पूर्व मध्य रेल्वे
South East Central Railway
डीजल लोको शेड, मोतीबाग, नागपुर
Diesel Loco Shed Motibagh, Nagpur

75
आज़ादी का
अमृत महोत्सव

प्रमाणपत्र

प्रमाणित किया जाता है की एस. बी. जैन संस्थान ऑफ़ तकनीकी प्रबंधन तथा अनुसंधान, नागपुर, महाराष्ट्र के श्री जागृत दे. मेहेर ने 11.07.2022 से 10.08.2022 तक डीजल लोको शेड, मोतीबाग, दक्षिण पूर्व मध्य रेल्वे, नागपुर, महाराष्ट्र में आयोजित भारतीय रेल के डीजल लोकोमोटिव पर इंटरशिप प्रशिक्षण पूरा किया है।

दिनांक: 15.09.2022

वरिष्ठ मंडल यांत्रिक इंजीनियर
द. पू. म. रेल्वे, मोतीबाग/ नागपुर
रक्षित मंडल तकनीक अधिकारी
Dr. Divy Mech, Engineer
द. पू. म. रेल्वे, मोतीबाग, नागपुर
3.09.2022



GENTECH

The G Force

An ISO 9001:2015
CERTIFIED COMPANY

Ref: GES/Trg/02

Date: 10.08.2022

To whomsoever it may concern.

This is to certify that **Ms. Janhavi Bopche** student of **S.B.Jain Institute of Technology , Management and Research , Nagpur** , branch of Mechanical Engineering has undergone One Month Summer Industrial Training for following work at various ongoing projects from **07.07.2022 to 08.08.2022**

1. Air-Conditioning
2. Refrigeration (Cold Storages & Ripening Chambers)
3. Fire Fighting Systems.

We found her hard working and performance was satisfactory.

Thanking You,

For Gentech Engineering Services

Nitin Rewatkar
Managing Partner



दक्षिण पूर्व मध्य रेल्वे
South East Central Railway
डीजल लोको शेड, मोतीबाग, नागपुर
Diesel Loco Shed Motibagh, Nagpur

75
आज़ादी का
अमृत महोत्सव

प्रमाणपत्र

प्रमाणित किया जाता है की एस. बी. जैन संस्थान ऑफ़ तकनीकी प्रबंधन तथा अनुसंधान, नागपुर, महाराष्ट्र के श्री कामेश हि. बावणे ने 11.07.2022 से 10.08.2022 तक डीजल लोको शेड, मोतीबाग, दक्षिण पूर्व मध्य रेल्वे, नागपुर, महाराष्ट्र में आयोजित भारतीय रेल के डीजल लोकोमोटिव पर इंटर्नशिप प्रशिक्षण पूरा किया है।

दिनांक: 15.09.2022

वरिष्ठ मंडल यांत्रिक इंजीनियर
द. पू. म. रेल्वे, मोतीबाग/नागपुर
इंजिनियरिंग विभाग
B. Div. Mech. Engineer
द. पू. म. रेल्वे, मोतीबाग, नागपुर
S.E.C. Railway, Motibagh, Nagpur

Certificate of Training

Kartik Pardhi

from S. B. Jain Institute of Technology, Management & Research Nagpur has successfully completed an 8-week online training on **Programming with C and C++**. The training consisted of Getting Started With Programming in C, Diving Into C Programming, Fundamentals of Object Oriented Programming Using CPP, Diving into CPP Programming, and Building Cricket Game Application modules.

In the final assessment, Kartik scored 76% marks.

We wish Kartik all the best for future endeavours.



Sarvesh Agarwal

FOUNDER & CEO, INTERNSHALA

Date of certification: 2022-09-10

Certificate no. : D6FC7454-F145-44B0-E505-5F6315F5B144

For certificate authentication, please visit https://trainings.internshala.com/verify_certificate



CERTIFICATE

INTERNSHIP & TRAINING PROGRAM

THIS CERTIFICATE PROUDLY PRESENTED TO

KAUSHIK WANAJRI

has successfully completed Training + Internship of "C, C++ & Data Structure Program" from August 2022 to September 2022 with extraordinary contribution, hard work & commitment.



A handwritten signature in black ink, appearing to read 'Kaushik Wanajri', written over a horizontal line.

DIRECTOR SIGNATURE

CERTIFICATE NUMBER: EDL-CI-377



दक्षिण पूर्व मध्य रेल्वे
South East Central Railway
डीजल लोको शेड, मोतीबाग, नागपुर
Diesel Loco Shed Motibagh, Nagpur

75
आज़ादी का
अमृत महोत्सव

प्रमाणपत्र

प्रमाणित किया जाता है की एस. बी. जैन संस्थान ऑफ़ तकनीकी प्रबंधन तथा अनुसंधान, नागपुर, महाराष्ट्र के श्री कुणाल प्र. चौधरी ने 11.07.2022 से 10.08.2022 तक डीजल लोको शेड, मोतीबाग, दक्षिण पूर्व मध्य रेल्वे, नागपुर, महाराष्ट्र में आयोजित भारतीय रेल के डीजल लोकोमोटिव पर इंटरनशिप प्रशिक्षण पूरा किया है।

दिनांक: 15.09.2022

वरिष्ठ मंडल यांत्रिक इंजीनियर
द. पू. म. रेल्वे, मोतीबाग/ नागपुर

For your reference, please refer to the following details:-
1. The name of the candidate is Mr. Kunjal P. Chaudhari.
2. The candidate is a student of the Diesel Loco Shed, Motibagh, Nagpur.
3. The candidate has completed the internship training on Diesel Loco Motive Power.



GENTECH

The G Force

An ISO 9001:2015
CERTIFIED COMPANY

Ref: GES/Trg/03

Date: 10.08.2022

To whomsoever it may concern.

This is to certify that **Mr.Kunal Nimkar** student of **S.B.Jain Institute of Technology , Management and Research , Nagpur** , branch of Mechanical Engineering has undergone One Month Summer Industrial Training for following work at various ongoing projects from **07.07.2022 to 08.08.2022**

1. Air-Conditioning
2. Refrigeration (Cold Storages & Ripening Chambers)
3. Fire Fighting Systems.

We found him hard working and performance was satisfactory.

Thanking You.

For Gentech Engineering Services

Nitin Rewatkar
Managing Partner

Certificate of Training

Laxmikant F.S. Patle

from S. B. Jain Institute Of Technology, Management & Research, Nagpur has successfully completed an 8-week online training on **Programming with C and C++**. The training consisted of Getting Started With Programming in C, Diving Into C Programming, Fundamentals of Object Oriented Programming Using CPP, Diving into CPP Programming, and Building Cricket Game Application modules.

In the final assessment, Laxmikant scored 84% marks.

We wish Laxmikant all the best for future endeavours.



Sarvesh Agarwal

FOUNDER & CEO, INTERNSHALA

Date of certification: 2022-11-10

Certificate no. : 9F62502D-BA79-84EF-7ED6-0D8E67BBBE90

For certificate authentication, please visit https://trainings.internshala.com/verify_certificate

Certificate of Training

MAHESH MESHRAM

has successfully completed a 6-week online training on **Programming with Python**. The training consisted of Introduction to Python, Using Variables in Python, Basics of Programming in Python, Principles of Object-oriented Programming (OOP), Connecting to SQLite Database, Developing a GUI with PyQt, Application of Python in Various Disciplines, and The Final Project modules.

MAHESH scored 100% marks in the final assessment and is a top performer in the training.

We wish MAHESH all the best for future endeavours.



Sarvesh Agarwal

FOUNDER & CEO, INTERNSHALA

Date of certification: 2022-08-27

Certificate no. : 0ABCA654-7BAC-6622-59C4-81C517110024

For certificate authentication, please visit https://trainings.internshala.com/verify_certificate

Certificate of Training

Manish Tukaram Rewatkar

from S. B. Jain Institute Of Technology, Management & Research, Nagpur has successfully completed an 8-week online training on **Web Development**. The training consisted of HTML, CSS, Bootstrap, DBMS, PHP, JS, React, and Final Project modules.

Manish Tukaram scored 98% marks in the final assessment and is a top performer in the training.

We wish Manish Tukaram all the best for future endeavours.



Sarvesh Agarwal

FOUNDER & CEO, INTERNSHALA

Date of certification: 2022-09-17

Certificate no. : 6A42A743-2ACE-B4ED-1EEE-F23D0BD11723

For certificate authentication, please visit https://trainings.internshala.com/verify_certificate



दक्षिण पूर्व मध्य रेल्वे
South East Central Railway
डीजल लोको शेड, मोतीबाग, नागापुर
Diesel Loco Shed Motibagh, Nagpur

आजादी का
अमृत महोत्सव

प्रमाणपत्र

प्रमाणित किया जाता है की एस. बी. जैन संस्थान ऑफ़ तकनीकी प्रबंधन तथा अनुसंधान, नागापुर, महाराष्ट्र के श्री मयूर नीलकमल आंबिलट्टुके ने 11.07.2022 से 10.08.2022 तक डीजल लोको शेड, मोतीबाग, दक्षिण पूर्व मध्य रेल्वे, नागापुर, महाराष्ट्र में आयोजित भारतीय रेल के डीजल लोकोमोटिव पर इंटर्नशिप प्रशिक्षण पूरा किया है।

दिनांक: 15.09.2022

वरिष्ठ मडल यांत्रिक इंजीनियर
द. पू. म. रेल्वे, मोतीबाग/ नागापुर

राजिव रंजन यांत्रिक अभियंता

Dr. P.M. Bapat, Engineer

र.पू.म. रेलवे, मोतीबाग, नागापुर

S.E.C.R. Motibagh, Nagpur

Certificate of Training

Milind Moreshwar Bawankule

from S. B. Jain Institute Of Technology, Management & Research, Nagpur has successfully completed an 8-week online training on **Web Development**. The training consisted of HTML, CSS, Bootstrap, DBMS, PHP, JS, React, and Final Project modules.

Milind Bawankule scored 98% marks in the final assessment and is a top performer in the training.
We wish Milind Bawankule all the best for future endeavours.



Sarvesh Agarwal

FOUNDER & CEO, INTERNSHALA

Date of certification: 2022-09-05

Certificate no. : 6A42A843-2ACE-B4ED-1EEE-F23D0BD11823

For certificate authentication, please visit https://trainings.internshala.com/verify_certificate

KRITIKA TECHNICAL ACADEMY

Technical Training Institute

Nagpur - 440013 Maharashtra (INDIA)



CERTIFICATE OF ACHIEVEMENT

Is awarded to Mr/Ms. MOHIT H. PANPATE

For successful completion of his/her internship course during

15/07/2022 - 20/08/2022

at small scale industries.

in Nagpur

Date of issue 01/09/2022

Er. VIJAY BHAMBRI
DIRECTOR



दक्षिण पूर्व मध्य रेल्वे
South East Central Railway
डीजल लोको शेड, मोतीबाग, नागपुर
Diesel Loco Shed Motibagh, Nagpur

75
आज़ादी का
अमृत महोत्सव

प्रमाणपत्र

प्रमाणित किया जाता है की एस. बी. जैन संस्थान ऑफ़ तकनीकी प्रबंधन तथा अनुसंधान, नागपुर, महाराष्ट्र के कुमारी मृणालिनी अरुण देशभतार ने 11.07.2022 से 10.08.2022 तक डीजल लोको शेड, मोतीबाग, दक्षिण पूर्व मध्य रेल्वे, नागपुर, महाराष्ट्र में आयोजित भारतीय रेल के डीजल लोकोमोटिव पर इंटर्नशिप प्रशिक्षण पूरा किया है।

दिनांक: 15.09.2022

वरिष्ठ/मंडल यांत्रिक इंजीनियर
द. पू. म. रेल्वे, मोतीबाग/नागपुर
Senior/Block Engineer
S.E.C.R., Motibagh, Nagpur
S.E.C.R., Motibagh, Nagpur

APML/2022-23/06

DATE:-05/08/2022

Adani Power Training & Research Institute (APTRI)

Certificate of Internship

This is to certify that **Mr. Muneshwar L Rahangdale** a Student of Third year B.E (Mechanical Engineering) of SB JAIN INSTITUTE OF TECHNOLOGY, MANAGEMENT & RESEARCH, NAGPUR had undergone Summer Internship in Mechanical Maintenances Department from 05/07/2022 to 05/08/2022.

His performance during the training period was found very Good.

We wish all success in his future endeavors.



Dr. Vijay V Gandhewar

GM (Tech. Training)

APML/2022-23/06

DATE:-05/08/2022

Adani Power Training & Research Institute (APTRI)

Certificate of Internship

This is to certify that **Mr. Nikhil B Rane** a Student of Third year
B.E (Mechanical Engineering) of SB JAIN INSTITUTE OF TECHNOLOGY,
MANAGEMENT & RESEARCH, NAGPUR had undergone Summer Internship
in Mechanical Maintenances Department from 05/07/2022 to 05/08/2022.

His performance during the training period was found very Good.

We wish all success in his future endeavors.



Dr. Vijay V Gandhewar

GM (Tech. Training)



Shri Balaji Fabrication

SPECIALIST : ALL KINDS OF FABRICATION & EXPORT PACKIAGING
W 30 OPP PIX TRANSMISSION MIDC HINGNA ROAD NAGPUR-440016
MOBILE 7798075876,EMAIL: shribalaji fabrication@yahoo.com

25-JULY-2022

CERTIFICATE

This is to Certify that under Mentioned Student has undergone internship / industrial Training at our Organization and successfully completed the same.

Name of student

Nikhil Shivkailash Kamdi

Name of college

S.B Jain Institute of tech, Management & Research Nagpur

Duration of training

25-June-2022 to 24-July-2022

We are Happy to note the keen interest shows by student during the training period

Best Wishes for bright future

For Shri Balaji Fabrication

Authorized signator



Certificate of Training

Nikhil Tekade

from S B Jain Institute Of Technology, Management & Research, Nagpur has successfully completed a 6-week online training on **Machine Learning**. The training consisted of Introduction to Machine Learning, Data, Introduction to Python, Data Exploration and Pre-processing, Linear Regression, Introduction to Dimensionality Reduction, Logistic Regression, Decision Tree, Ensemble Models, and Clustering (Unsupervised Learning) modules.

Nikhil scored 100% marks in the final assessment and is a top performer in the training.

We wish Nikhil all the best for future endeavours.



Sarvesh Agarwal

FOUNDER & CEO, INTERNSHALA

Date of certification: 2022-09-17

Certificate no. : 4356EDBA-B77E-C012-6CEE-BA72978A73C4

For certificate authentication, please visit https://trainings.internshala.com/verify_certificate



दक्षिण पूर्व मध्य रेल्वे

South East Central Railway

डीजल लोको शेड, मोतीबाग, नागपुर

Diesel Loco Shed Motibagh, Nagpur



प्रमाणपत्र

प्रमाणित किया जाता है की एस. बी. जैन संस्थान ऑफ़ तकनीकी प्रबंधन तथा अनुसंधान, नागपुर, महाराष्ट्र के श्री ओम संजय बारंगे ने 11.07.2022 से 10.08.2022 तक डीजल लोको शेड, मोतीबाग, दक्षिण पूर्व मध्य रेल्वे, नागपुर, महाराष्ट्र में आयोजित भारतीय रेल के डीजल लोकोमोटिव पर इंटरनशिप प्रशिक्षण पूरा किया है।

दिनांक: 15.09.2022

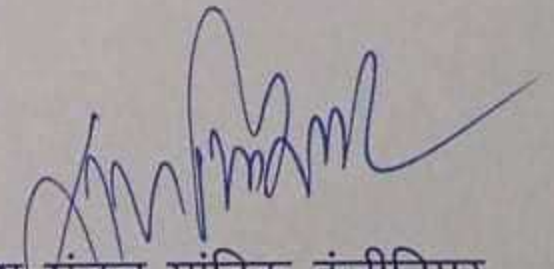
वरिष्ठ मंडल यांत्रिक इंजीनियर
द. पू. म. रेल्वे, मोतीबाग/ नागपुर
वरिष्ठ मंडल यांत्रिक अभियंता
Sr. Divl. Mech. Engineer
द.पु.म. रेलवे, मोतीबाग, नागपुर
S.E.C. Railway, Motibagh, Nagpur

Panorama Digital Marketing

Chintamani, Holy Cross Rd, Adarsh Nagar, Kalyani Nagar,
Pune, Maharashtra 411015

DATE: 08.10.2022

INTERNSHIP CERTIFICATE

We are happy to certify that **Mr. Palash S. Nimje** has done work at home internship as Digital Marketing Intern during **2 May 2022 to 1 June 2022**. We appreciate his work and contributions.



Panorama Digital Marketing



PANORAMA
DIGITAL MARKETING

Panorama Digital Marketing

Chintamani, Holy Cross Rd, Adarsh Nagar, Kalyani Nagar,
Pune, Maharashtra 411015

DATE: 08.10.2022

INTERNSHIP CERTIFICATE

We are happy to certify that **Mr. Pankaj Makode** has done work at home internship as Digital Marketing Intern during **2 May 2022 to 1 June 2022**. We appreciate his work and contributions.



Panorama Digital Marketing



PANORAMA
DIGITAL MARKETING



M.S.R.T. CORPORATION, BHANDARA DIVISION, BHANDARA
NATIONAL HIGHWAY-6 NAGPUR ROAD BHANDARA-441904



Phone No. 07184-252496, e-mail ; meo_stbhn@yahoo.com

No. ST/MEO/BHN/DWS/Training/2022-23/2151

Date:- 19-08-2022

TO WHOMSOEVER IT MAY CONCERN

This is to certify that Mr. Pranay Mangaru Kavgate student of S. B. Jain Institute of Technology, Management & Research, Nagpur has done his 1 Month internship/ industrial training at M.S.R.T. Corporation, Bhandara Division, Bhandara from 20 July 2022 to 19 August 2022.

During the period of his internship program with us, he had been exposed to different processes and was found punctual, hardworking, and inquisitive.

We wish him every success in his life and career.

Mechanical Engineer (OPN)
S. T. Bhandara

Mechanical Engineer
S.T. Bhandara



M.S.R.T. CORPORATION, BHANDARA DIVISION, BHANDARA
NATIONAL HIGHWAY-6 NAGPUR ROAD BHANDARA-441904



Phone No. 07184-252496, e-mail ; meo_stbhn@yahoo.com

No. ST/MEO/BHN/DWS/Training/2022-23/2151

Date:- 19-08-2022

TO WHOMSOEVER IT MAY CONCERN

This is to certify that Mr. Pranay Rajkumar Sukhadeve student of S. B. Jain Institute of Technology, Management & Research, Nagpur has done his 1 Month internship/ industrial training at M.S.R.T. Corporation, Bhandara Division, Bhandara from 20 July 2022 to 19 August 2022.

During the period of his internship program with us, he had been exposed to different processes and was found punctual, hardworking, and inquisitive.

We wish him every success in his life and career.

Mechanical Engineer (OPN)
S. T. Bhandara

Mechanical Engineer
S.T. Bhandara

Sri Bhagirath Textiles Ltd.

Regd. Office : Sarvodaya Cloth Market, Goodbough, Nagpur - 440002 (India)
Tel : +91-712-2760033 | Fax : +91-712-2760033
Website: www.sbtindia.com | Email: info@sbtindia.com
CIN No. U31100MH1991PLC006047



SB RANDE
GROUP

KNOWLEDGE FROM THE ABOVE

July 20th, 2022

Mohali

TO WHOM SO EVER IT MAY CONCERN

This is to certify that **Mr. Pranil V. Dudhkawale** has successfully completed his training in Mechanical Department, from 08th June, 2022 to 08th July, 2022 in our organization.

For: Sri Bhagirath Textiles Ltd.

Manager_HR



Sri Bhagirath Textiles Ltd.

Regd. Office : Sarvodaya Cloth Market, Gandhibagh, Nagpur - 440002 (India)
Tel : +91-712-2769035 | Fax : +91-712-2765845
Website: www.sbtindia.com | Email: info@sbtindia.com
CIN No: U17100MH1991PLC060542



SB RANDE
GROUP

RIISING FROM THE ROOTS

July 20th, 2022

Mohali

TO WHOM SO EVER IT MAY CONCERN

This is to certify that **Mr. Pranit G. Dagade** has successfully completed his training in Mechanical Department, form 08th June, 2022 to 08th July, 2022 in our organization.

For: Sri Bhagirath Textiles Ltd.

Manager HR

KEYANN ENGINEERING LLP

Off. Add.: 14, Sidhpura Co-op Industrial Estate, S.V. Road, Goregaon (W), Mumbai - 400062
Factory Add. : K-32/2, MIDC Hingna, Nagpur- 440016. Mob.: 07104 - 232316, 232317

Date: 16/08/22

Certificate

This is to certify that Mr. Prateek Tinguria student of Mechanical Engineering from S.B Jain Institute of technology management and research, Nagpur has completed Internship successfully from 14th July 2022 to 13th August 2022. During this period, he has shown good interest in the assignment/works given to him and worked hard. During his tenure of internship, he was hard working and focused on activities assigned to him.

Regards,

Signature - 

Name of HR Head - Mrs. Nikita V. Kamble

Designation - Plant Co-Ordinator

Industry Name & Address -

M/S. Keyann Engineering LLP

K32/2, MIDC, Hingna, Nagpur-16.



Certificate of Training

Pratik Dhandale

from S.B. Jain Institute of Technology, Management and Research, Nagpur has successfully completed an 8-week online training on **Web Development**. The training consisted of HTML, CSS, Bootstrap, DBMS, PHP, JS, React, and Final Project modules.

In the final assessment, Pratik scored 60% marks.

We wish Pratik all the best for future endeavours.



Sarvesh Agarwal

FOUNDER & CEO, INTERNSHALA

Date of certification: 2022-09-04

Certificate no. : 16ED12B6-9498-38BF-E49B-6E4382914797

For certificate authentication, please visit https://trainings.internshala.com/verify_certificate

TRAINING CERTIFICATE

This is to certify that **Mr. Pratik Rodge**, student of **S.B Jain Institute of Technology, Management & Research** has completed his **1-month** internship with us, from **11th July, 2022 to 9th August, 2022**.

As part of the internship he has done a study in the department of **"Transmission Machining"** as **"Diploma Engineering Trainee"** employee.

During the tenure with us, we found **Mr. Pratik Rodge**, sincere and result oriented.



For Mahindra & Mahindra Tractors Ltd.

Sanjay Sure

Transmission Machining Department - Line Head

Certificate of Completion

Registration Number
CADD-143800001

Awarded to : PRINSHU DUBEY



For : Master in Drafting

Software Used : AutoCAD(2D+3D)

Passing Date : July 2022

Center : Doonagar, Nagpur



CADDTM MASTRE

ISO 9001-2008 Certified Company

Alish S. Bawankar
Director

Amrut Gandalekar
Center Manager

Certificate Issue No: EA-ON2022

CADD MASTRE & CADD MASTRE Logo Are Registered Trade Marks Of Cadd Mastre Training Services
www.caddmastre.com | 200, Umaprakash Apt, Golapnagar Market, Nagpur

CADD MASTRE MASTRE Logo Are Registered in Many Countries Worldwide. Copyright © 2022

Panorama Digital Marketing

Chintamani, Holy Cross Rd, Adarsh Nagar, Kalyani Nagar,
Pune, Maharashtra 411015

DATE: 08.10.2022

INTERNSHIP CERTIFICATE

We are happy to certify that **Mr. Priyank K. Patil** has done work at home internship as Digital Marketing Intern during **2 May 2022 to 1 June 2022**. We appreciate his work and contributions.



Panorama Digital Marketing



PANORAMA
DIGITAL MARKETING



CERTIFICATE

INTERNSHIP & TRAINING PROGRAM

THIS CERTIFICATE PROUDLY PRESENTED TO:

PRIYANSHU SAKHARE

has successfully completed Training + Internship of 'C, C++ & Data Structure Program' from August 2022 to September 2022 with extraordinary contribution, hard work & commitment.



A handwritten signature in black ink, appearing to be 'D.A.', written over a horizontal line.

DIRECTOR SIGNATURE

CERTIFICATE NUMBER: EDL-CI-373



M.S.R.T. CORPORATION, BHANDARA DIVISION, BHANDARA
NATIONAL HIGHWAY-6 NAGPUR ROAD BHANDARA-441904



Phone No. 07184-252496, e-mail ; meo_stbhn@yahoo.com

No. ST/MEO/BHN/DWS/Training/2022-23/2151

Date:- 19-08-2022

TO WHOMSOEVER IT MAY CONCERN

This is to certify that Mr. Raja Omprakash Tembhone student of S. B. Jain Institute of Technology, Management & Research, Nagpur has done his 1 Month internship/ industrial training at M.S.R.T. Corporation, Bhandara Division, Bhandara from 20 July 2022 to 19 August 2022.

During the period of his internship program with us, he had been exposed to different processes and was found punctual, hardworking, and inquisitive.

We wish him every success in his life and career.

Mechanical Engineer (OPN)
S. T. Bhandara

Mechanical Engineer
S.T. Bhandara



दक्षिण पूर्व मध्य रेल्वे
South East Central Railway
डीजल लोको शेड, मोतीबाग, नागपुर
Diesel Loco Shed Motibagh, Nagpur

75
आज़ादी का
अमृत महोत्सव

प्रमाणपत्र

प्रमाणित किया जाता है की एस. बी. जैन संस्थान ऑफ तकनीकी प्रबंधन तथा अनुसंधान, नागपुर, महाराष्ट्र के श्री रेशम नथु वासनिक ने 11.07.2022 से 10.08.2022 तक डीजल लोको शेड, मोतीबाग, दक्षिण पूर्व मध्य रेल्वे, नागपुर, महाराष्ट्र में आयोजित भारतीय रेल के डीजल लोकोमोटिव पर इंटर्नशिप प्रशिक्षण पूरा किया है।

दिनांक: 15/09/2022

वरिष्ठ मंडल यांत्रिक इंजीनियर
द पू म रेल्वे, मोतीबाग/नागपुर
रजिस्टर संख्या: 15/09/2022
Dr. Divy Meek, Engineer
S.E.C.R. Motibagh, Nagpur
S.E.C.R. Motibagh, Nagpur



12th July 2022

CERTIFICATE

This is to certify that under mentioned student has undergone Internship / Industrial Training in our organization and successfully completed the same.

Name of the student : **Mr. Ritesh N Puri**
3rd year - BE (Mechanical)
Name of College : **SB Jain Engineering College, Nagpur**
Duration of Training : **8th June 2022 to 8th July 2022**

We are happy to note the keen interest shown by the student during the training period.

Best Wishes for a bright future.

For JSW Steel Coated Products Limited

12-7-22
Authorised Signatory



Certificate of Training

Ritesh Zingare

from S. B. Jain Institute Of Technology, Management & Research, Nagpur has successfully completed a 6-week online training on **Programming with Python**. The training consisted of Introduction to Python, Using Variables in Python, Basics of Programming in Python, Principles of Object-oriented Programming (OOP), Connecting to SQLite Database, Developing a GUI with PyQt, Application of Python in Various Disciplines, and The Final Project modules.

Ritesh scored 90% marks in the final assessment and is a top performer in the training.
We wish Ritesh all the best for future endeavours.



Sarvesh Agarwal

FOUNDER & CEO, INTERNSHALA

Date of certification: 2022-08-11

Certificate no. : D621A749-FCC7-20DD-95B1-024D9F2DBF4D

For certificate authentication, please visit https://trainings.internshala.com/verify_certificate



JSW Steel
Coated Products Limited
A-10/1 & 10/2 MIDC Industrial Area,
Kalmeshwar - 441 501,
Dist. Nagpur, Maharashtra,

Phone : (07118) 271401-06
Fax : (07118) 271128
Website : www.jsw.in

CIN No. U27100MH1985PLC037346

12th July 2022

CERTIFICATE

This is to certify that under mentioned student has undergone Internship / Industrial Training in our organization and successfully completed the same.

Name of the student : **Mr. Ritik V Gotmare**
3rd year - BE (Mechanical)
Name of College : **SB Jain Engineering College, Nagpur**
Duration of Training : **8th June 2022 to 8th July 2022**

We are happy to note the keen interest shown by the student during the training period.

Best Wishes for a bright future.

For JSW Steel Coated Products Limited

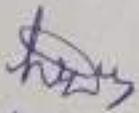
12-7-22

Authorised Signatory



Certificate of Training

Rohit Dehankar

from S. B. Jain Institute of Technology, Management & Research, Nagpur has successfully completed a 6-week online training on **Programming with Python**. The training consisted of Introduction to Python, Using Variables in Python, Basics of Programming in Python, Principles of Object-oriented Programming (OOP), Connecting to SQLite Database, Developing a GUI with PyQt, Application of Python in Various Disciplines, and The Final Project modules.

In the final assessment, Rohit scored 88% marks.
We wish Rohit all the best for future endeavours.



Sarvesh Agarwal

FOUNDER & CEO, INTERNSHALA

Date of certification: 2022-08-07 Certificate no. : E67AD43F-75C6-DC3B-6E2A-2389E2C634A0

For certificate authentication, please visit https://trainings.internshala.com/verify_certificate



M.S.R.T. CORPORATION, BHANDARA DIVISION, BHANDARA
NATIONAL HIGHWAY-6 NAGPUR ROAD BHANDARA-441904



Phone No. 07184-252496, e-mail ; meo_stbhn@yahoo.com

No. ST/MEO/BHN/DWS/Training/2022-23/2151

Date:- 19-08-2022

TO WHOMSOEVER IT MAY CONCERN

This is to certify that Mr. Rohit Shrikant Gaidhane student of S. B. Jain Institute of Technology, Management & Research, Nagpur has done his 1 Month internship/ industrial training at M.S.R.T. Corporation, Bhandara Division, Bhandara from 20 July 2022 to 19 August 2022.

During the period of his internship program with us, he had been exposed to different processes and was found punctual, hardworking, and inquisitive.

We wish him every success in his life and career.

Mechanical Engineer (OPN)
S. T. Bhandara

Mechanical Engineer
S.T. Bhandara



Gustovalley Technovations

CERTIFICATE OF COMPLETION

This Certifies that

Sahil Sanjay Mahant

has successfully completed 'Gustovalley Technovations' Internship Training Program on IOT which was conducted from 11 JUL 2022 to 20 AUG 2022.

The Performance delivered during the program was Good

Authorized Signatory

Certificate No. : GL5111

KRITIKA TECHNICAL ACADEMY

Technical Training Institute

Nagpur - 440013 Maharashtra (INDIA)



CERTIFICATE OF ACHIEVEMENT

Is awarded to Mr/Ms.**SAHIL P. SONTAKKE**.....
For successful completion of his/her internship course during
.....**15/07/2022** - **20/08/2022**..... at small scale industries.
in Nagpur

Date of issue **01/09/2022**

Vijay K.

Er. VIJAY BHAMBRI
DIRECTOR



M.S.R.T. CORPORATION, BHANDARA DIVISION, BHANDARA
NATIONAL HIGHWAY-6 NAGPUR ROAD BHANDARA-441904



Phone No. 07184-252496, e-mail ; meo_stbhn@yahoo.com

No. ST/MEO/BHN/DWS/Training/2022-23/2151

Date:- 19-08-2022

TO WHOMSOEVER IT MAY CONCERN

This is to certify that Mr. Sandesh Ramchandra Raut student of S. B. Jain Institute of Technology, Management & Research, Nagpur has done his 1 Month internship/ industrial training at M.S.R.T. Corporation, Bhandara Division, Bhandara from 20 July 2022 to 19 August 2022.

During the period of his internship program with us, he had been exposed to different processes and was found punctual, hardworking, and inquisitive.

We wish him every success in his life and career.

Mechanical Engineer (OPN)
S. T. Bhandara

Mechanical Engineer
S.T. Bhandara



दक्षिण पूर्व मध्य रेल्वे

South East Central Railway

डीजल लोको शेड, मोतीबाग, नागपुर

Diesel Loco Shed Motibagh, Nagpur



प्रमाणपत्र

प्रमाणित किया जाता है की एस. बी. जैन संस्थान ऑफ़ तकनीकी प्रबंधन तथा अनुसंधान, नागपुर, महाराष्ट्र के श्री संदिप संजय टेंभरे ने 11.07.2022 से 10.08.2022 तक डीजल लोको शेड, मोतीबाग, दक्षिण पूर्व मध्य रेल्वे, नागपुर, महाराष्ट्र में आयोजित भारतीय रेल के डीजल लोकोमोटिव पर इंटर्नशिप प्रशिक्षण पूरा किया है।

दिनांक: 15-09-2022

वरिष्ठ मंडल यांत्रिक इंजीनियर

द. पू. म. रेल्वे, मोतीबाग/ नागपुर

राजिव गंधार वाणिज्य अस्पताल

Dr. D.M. Laxkar, Engineer

द. पू. म. रेल्वे, मोतीबाग, नागपुर

S.E.C. Railway, Motibagh, Nagpur



दक्षिण पूरव मध्य रेल्वे
South East Central Railway
डीजल लोको शेड, मोतीबाग, नागपुर
Diesel Loco Shed Motibagh, Nagpur

75
आज़ादी का
अमृत महोत्सव

प्रमाणपत्र

प्रमाणित किया जाता है की एस. बी. जैन संस्थान ऑफ़ तकनीकी प्रबंधन तथा अनुसंधान, नागपुर, महाराष्ट्र के श्री संगम ओ. डहरवाल ने 11.07.2022 से 10.08.2022 तक डीजल लोको शेड, मोतीबाग, दक्षिण पूर्व मध्य रेल्वे, नागपुर, महाराष्ट्र में आयोजित भारतीय रेल के डीजल लोकोमोटिव पर इंटर्नशिप प्रशिक्षण पूरा किया है।

दिनांक: 15-09-2022

वरिष्ठ मंडल यांत्रिक इंजीनियर
द. पू. म. रेल्वे, मोतीबाग/नागपुर
रिफ़ा नंदाय यांत्रिक अभियंता
Sr. Div. Mech. Engineer
D.P.M. Railway, Motibagh, Nagpur
S.E.C. Railway, Motibagh, Nagpur



SIEMENS
Ingenuity for life



Visvesvaraya National Institute of Technology Nagpur

V. R. Jamdar Siemens Center of Excellence
Industry 4.0 & Digitalization

CERTIFICATE OF COURSE COMPLETION

This is to certify that

Sanket Sudaiv Janbandhu

has successfully completed the Internship in

Smart Manufacturing

from 6th July , 2022 - 6th August , 2022

Director

Visvesvaraya National Institute of
Technology, Nagpur

Business Head

Business Head- federal &
Academics SIEMENS

Director

3D Engineering Automation LLP

Certificate ID- 3D_VRJSOE_00031

Sri Bhagirath Textiles Ltd.

Regd. Office : Sarvodaya Cloth Market, Gandhinagar, Nagpur - 440002 (India)
Tel : +91-712-2760035 | Fax : +91-712-2760843
Website: www.sbtindia.com | Email: info@sbtindia.com
CIN No. U17100MH1991PLC090542



SB RANDER
GROUP

WORLD FROM THE ABOVE

July 20th, 2022

Mohali

TO WHOM SO EVER IT MAY CONCERN

This is to certify that **Mr. Sanket R. Pawade** has successfully completed his training in Engineering Department, from 08th June, 2022 to 08th July, 2022 in our organisation.

For: Sri Bhagirath Textiles Ltd.

Manager HR





Ref: GES/Trg/05

Date: 10.08.2022

To whomsoever it may concern.

This is to certify that **Mr.Sarvesh Neware** student of **S.B.Jain Institute of Technology , Management and Research , Nagpur** , branch of Mechanical Engineering has undergone One Month Summer Industrial Training for following work at various ongoing projects from **07.07.2022 to 08.08.2022**

1. Air-Conditioning
2. Refrigeration (Cold Storages & Ripening Chambers)
3. Fire Fighting Systems.

We found him hard working and performance was satisfactory.

Thanking You,

For Gentech Engineering Services

Nitin Rewatkar
Managing Partner



SIEMENS
Ingenuity for life



Visvesvaraya National Institute of Technology Nagpur

V. R. Jamdar Siemens Center of Excellence
Industry 4.0 & Digitalization

CERTIFICATE OF COURSE COMPLETION

This is to certify that

Shravan Shankar Wadekar

has successfully completed the Internship in

Smart Manufacturing

from 6th July , 2022 - 6th August , 2022

Director

Visvesvaraya National Institute of
Technology, Nagpur

Business Head

Business Head- federal &
Academics SIEMENS

Director

3D Engineering Automation LLP

Certificate ID- 3D_VRJSOE_00029



12th July 2022

CERTIFICATE

This is to certify that under mentioned student has undergone Internship / Industrial Training in our organization and successfully completed the same.

Name of the student : **Mr. Shreyash P Adhao**
3rd year - BE (Mechanical)
Name of College : **SB Jain Engineering College, Nagpur**
Duration of Training : **8th June 2022 to 8th July 2022**

We are happy to note the keen interest shown by the student during the training period.

Best Wishes for a bright future.

For JSW Steel Coated Products Limited

12-7-22

Authorised Signatory



Engineering Services



GENTECH

The G Force

An ISO 9001:2015
CERTIFIED COMPANY

Ref: GES/Trg/07

Date:10.08.2022

To whomsoever it may concern.

This is to certify that **Mr.Shrayash Vaidya** student of **S.B.Jain Institute of Technology , Management and Research , Nagpur ,** branch of Mechanical Engineering has undergone One Month Summer Industrial Training for following work at various ongoing projects from 07.07.2022 to 08.08.2022

1. Air-Conditioning
2. Refrigeration (Cold Storages & Ripening Chambers)
3. Fire Fighting Systems.

We found him hard working and performance was satisfactory.

Thanking You,

For Gentech Engineering Services

Nitin Rewatkar
Managing Partner

Mahindra

Date: 22/09/2022

TRAINING CERTIFICATE

This is to certify that Mr. Shubham Patre, student of S.B Jain Institute of Technology, Management & Research has completed his 1-month internship with us, from 11th July, 2022 to 9th August, 2022.

As part of the internship he has done a study in the department of "Transmission Machining" as "Diploma Engineering Trainee" employee.

During the tenure with us, we found Mr. Shubham Patre, sincere and result oriented.

For Mahindra & Mahindra Tractors Ltd.

Sanjay Sure

Transmission Machining Department - Line Head



CERTIFICATE

INTERNSHIP & TRAINING PROGRAM

THIS CERTIFICATE PROUDLY PRESENTED TO

SIDRAH KHAN

has successfully completed **Training + Internship of 'C, C++ & Data Structure Program'** from **August 2022 to September 2022** with extraordinary contribution, hard work & commitment.



A handwritten signature in black ink, appearing to be 'SA'.

DIRECTOR SIGNATURE

CERTIFICATE NUMBER: EDL-CI-352



GENTECH

The G Force

An ISO 9001:2015
CERTIFIED COMPANY

Ref: GES/Trg/04

Date:10.08.2022

To whomsoever it may concern.

This is to certify that **Mr.Sudip Pidkalwar** student of **S.B.Jain Institute of Technology , Management and Research , Nagpur** , branch of Mechanical Engineering has undergone One Month Summer Industrial Training for following work at various ongoing projects from **07.07.2022 to 08.08.2022**

1. Air-Conditioning
2. Refrigeration (Cold Storages & Ripening Chambers)
3. Fire Fighting Systems.

We found him hard working and performance was satisfactory.

Thanking You,

For **Gentech Engineering Services**

Nitin Rewatkar
Managing Partner

KEYANN ENGINEERING LLP

Off. Add.: 14, Sidhpura Co-op Industrial Estate, S.V. Road, Goregaon (W), Mumbai - 400062

Factory Add. : K-32/2, MIDC Hingna, Nagpur- 440016. Mob.: 07104 - 232316, 232317

Date: 16/03/2022

Certificate

This is to certify that Mr. Sujit Patil student of Mechanical Engineering from S.B Jain Institute of technology management and research, Nagpur has completed Internship successfully from 4th July 2022 to 3rd August 2022. During this period, he has shown good interest in the assignment/works given to him and worked hard. During his tenure of internship, he was hard working and focused on activities assigned to him.

Regards,

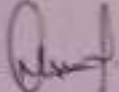
Signature - 

Name of HR Head - Mrs. Nikita V. Kamble

Designation - Plant Co-Ordinator

Industry Name & Address -

M/S. Keyann Engineering LLP

K32/2, MIDC, Hingna, Nagpur-16.





Shri Balaji Fabrication

SPECIALIST : ALL KINDS OF FABRICATION & EXPORT PACKIAGING
W 30 OPP PIX TRANSMISSION MIDC HINGNA ROAD NAGPUR-440018
MOBILE 7798075876,EMAIL: shribalaji fabrication@yahoo.com

25 JULY 2022

CERTIFICATE

This is to Certify that under Mentioned Student has undergone internship / Industrial Training in our Organization and successfully completed the same

Name of student	Sushant Kailash Bharti
Name of college	S.B Jain Institute of tech, Management & Research Nagpur
Duration of training	25-June-2022 to 24-July-2022

We are Happy to note the keen interest shown by student during the training period

Best Wishes for bright future

For Shri Balaji Fabrication

Authorized signatory



KRITIKA TECHNICAL ACADEMY

Technical Training Institute

Nagpur - 440013 Maharashtra (INDIA)



CERTIFICATE OF ACHIEVEMENT

Is awarded to Mr/Ms. SWAPNEE S. ORAKEY

For successful completion of his/her internship course during

18/07/2022 - 20/08/2022

..... at small scale industries.

in Nagpur

Date of issue 01/09/2022

Er. VIJAY BHAMBRI
DIRECTOR



BSD MEP
BUILDING SERVICES DESIGN
MEP CONSULTANTS

"Suman" 158-B - Ground Floor

Hill Top, Ambazari - Nagpur 440010

Contact: 9970083027, 7447447030

Email bsdnep@gmail.com

Date: 30.09.2022

TO WHOMSOEVER IT MAY CONCERN

This is to certify that Mr. Tanishq S. Paraye Student of Mechanical Engineering from S.B. Jain Institute of technology Management & research , Nagpur has Completed Internship Successfully From 5th July 2022 to 5th August 2022 During this Period , he has shown good interest in the assignment works given to him and worked hard. During this tenure of internship, he was hard working and focused on activities assigned to him.

For,



BSD

Building Services Design

MEP Consultant



INDO GERMAN TOOL ROOM, AURANGABAD
(A Government of India Society, Ministry of MSME)
EXTENSION CENTRE - NAGPUR



IGTR/NGP/2022-23/31

Saturday, August 6, 2022

CERTIFICATE

This is to certify that **Mr. BAGDE VAIBHAV VIKAS** student of S. B. Jain Institute of Technology, Management & Research Nagpur had successful completed Six Weeks **IN-PLANT TRAINING PROGRAM** at MSME Technology Center, Indo German Tool Room, Aurangabad Extension Center, Nagpur from 06/07/22 to 13/08/2022.

For, MSME IGTR Aurangabad EC, Nagpur

I. Haque

Engineer(CAD/CAM)



P-142, M.I.D.C. INDUSTRIAL AREA, HINGNA, NAGPUR – 440028 (M.S.) INDIA

Email : training_ngp@igtr-aur.org, Web-site : www.igtr-au.org

Phone : (07104)-297136, Mob. No. : 9075095552



CERTIFICATE

INTERNSHIP & TRAINING PROGRAM

THIS CERTIFICATE PROUDLY PRESENTED TO

VAISHNAVI CHOURASIA

has successfully completed **Training + Internship of 'C, C++ & Data Structure Program'** from **August 2022 to September 2022** with extraordinary contribution, hard work & commitment.



A handwritten signature in black ink, appearing to be 'D.A.', written over a horizontal line.

DIRECTOR SIGNATURE

CERTIFICATE NUMBER: EDL-CI-490

SINGH ENGINEERING WORK
20/5 Near Kalya Machining
MIDC Wanadongri,
Hingna Road,
Nagpur-440028

Mob. No. 9372452865
Email Id. ramnathsingh.nagpur@gmail.com

PAN. No:-BLSPS6846N

Date:- Aug10, 2022.

This is to certify **Mr. Vedant Sudhir Kindar** student of **S. B. JAIN Institute of Technology, Management, and Research, Nagpur**, Branch of Mechanical Engineering has undergone 1-month of Summer Industrial Training in various sections of this organization **Singh Engineering Work** from 6/7/2022 to 10/8/2022

His performance during the above period has been found satisfactory

Yours faithfully,

For **Singh Engineering Work**

RAM NATH SINGH

(Authorized Signatory)

SINGH ENGINEERING WORK
P-20/5, M.I.D.C., Hingna
Nagpur



M.S.R.T. CORPORATION, BHANDARA DIVISION, BHANDARA
NATIONAL HIGHWAY-6 NAGPUR ROAD BHANDARA-441904



Phone No. 07184-252496, e-mail ; meo_stbhn@yahoo.com

No. ST/MEO/BHN/DWS/Training/2022-23/2151

Date:- 19-08-2022

TO WHOMSOEVER IT MAY CONCERN

This is to certify that Mr. Vishal Ramesh Chopkar student of S. B. Jain Institute of Technology, Management & Research, Nagpur has done his 1 Month internship/ industrial training at M.S.R.T. Corporation, Bhandara Division, Bhandara from 20 July 2022 to 19 August 2022.

During the period of his internship program with us, he had been exposed to different processes and was found punctual, hardworking, and inquisitive.

We wish him every success in his life and career.

Mechanical Engineer (OPN)
S. T. Bhandara

Mechanical Engineer
S.T. Bhandara



CERTIFICATE

INTERNSHIP & TRAINING PROGRAM

THIS CERTIFICATE PROUDLY PRESENTED TO:

VISHAL DHANWATEA

has successfully completed Training + Internship of 'C, C++ & Data Structure Program' from August 2022 to September 2022 with extraordinary contribution, hard work & commitment.



A handwritten signature in black ink, appearing to be 'V. Dhanwate'.

DIRECTOR SIGNATURE

CERTIFICATE NUMBER: EDL-CI-403

KRITIKA TECHNICAL ACADEMY

Technical Training Institute

Nagpur - 440013 Maharashtra (INDIA)



CERTIFICATE OF ACHIEVEMENT

Is awarded to Mr/Ms.VISHAL D. SHAMARE.....

For successful completion of his/her internship course during

.....15/07/2022 - 20/08/2022..... at small scale industries.
in Nagpur

Date of issue 01/09/2022

ER. VIJAY BHAMBRI
DIRECTOR



SIEMENS
Ingenuity for life



Visvesvaraya National Institute of Technology Nagpur

V. R. Jamdar Siemens Center of Excellence
Industry 4.0 & Digitalization

CERTIFICATE OF COURSE COMPLETION

This is to certify that

Vrushabh Bodhe

has successfully completed the Internship in

Smart Manufacturing

from 6th July , 2022 - 6th August , 2022

Director

Visvesvaraya National Institute of
Technology, Nagpur

Business Head

Business Head- federal &
Academics SIEMENS

Director

3D Engineering Automation LLP

Certificate ID- 3D_VRJSOE_00030

KRITIKA TECHNICAL ACADEMY

Technical Training Institute

Nagpur - 440013 Maharashtra (INDIA)



CERTIFICATE OF ACHIEVEMENT

Is awarded to Mr/Ms.**MRUSHARH S. YESANSURE**.....

For successful completion of his/her internship course during

.....**15/07/2022 - 20/08/2022**..... at small scale industries.
in Nagpur

Date of issue **01/09/2022**

ER. VIJAY BHAMBRI
DIRECTOR



CERTIFICATE

INTERNSHIP & TRAINING PROGRAM

THIS CERTIFICATE PROUDLY PRESENTED TO:

YASH GHORPADE

has successfully completed Training + Internship of 'C, C++ & Data Structure Program' from August 2022 to September 2022 with extraordinary contribution, hard work & commitment.



A handwritten signature in black ink, appearing to be 'Yash Ghorpade', written over a horizontal line.

DIRECTOR SIGNATURE

CERTIFICATE NUMBER: EDL-CI-376

KEYANN ENGINEERING LLP

Off. Add.: 14, Sidhpura Co-op Industrial Estate, S.V. Road, Goregaon (W), Mumbai - 400062
Factory Add. : K-32/2, MIDC Hingna, Nagpur- 440016. Mob.: 07104 - 232316, 232317

Date : 16/08/22

Certificate

This is to certify that Mr. Yash Thakre student of Mechanical Engineering from S.B Jain Institute of technology management and research, Nagpur has completed Internship successfully from 14th July 2022 to 13th August 2022. During this period, he has shown good interest in the assignment/works given to him and worked hard. During his tenure of internship, he was hard working and focused on activities assigned to him.

Regards,

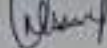
Signature - 

Name of HR Head - Mrs. Nikita V. Kamble

Designation - Plant Co-Ordinator

Industry Name & Address -

M/S. Keyann Engineering LLP

K32/2, MIDC, Hingna, Nagpur-16.



The Trust of Family



SPARKK CHEM INDUSTRIES

By Pass Road Industrial Area MIDC, Amravati (M.S.) 444701
Customer Care : tulpluscare@gmail.com
www.sparkkindustries.com

Ref.No. SCI/MD/455/52

Date: 05/10/2022

Certificate of Internship

This is to certify that Mr. Shashank Anil Bangar have successfully completed his internship in Marketing Department as a Marketing Management Intern (from 17th August 2022 to 4th October 2022) you have shown true commitment and diligence during the period of this internship and have successfully completed all tasks.

SPARK CHEM INDUSTRIES

CERTIFICATE OF COMPLETION

Date: 12 Dec, 2022

This certificate is awarded to

Mr. Kapil Thool

in appreciation for his successful work as an intern in Zielhoch Company.

he has completed his Summer Internship with project title

"Marketing And Recruitment Strategies"

Under the guidance of

Mr. Harshit Sharma

Project duration
10 Oct, 2022 to 10 Dec, 2022

The internship assessment fulfils the stated criteria and student findings are his original work.

We hereby certify his work satisfactory to the best of my knowledge with an aggregate
Grade A-

Location for internship-
Delhi - NCR / Work from Home

We wish him all the best for future endeavours.

Warm Regards



(Authorized Signatory)
HUMAN RESOURCE
Zielhoch

CERTIFICATE OF COMPLETION

Date: 24 Jan, 2023

This certificate is awarded to

Ms. Pooja Prakash Dongare

in appreciation for her successful work as an intern in Zielhoch Company.

she has completed her Summer Internship with project title

"Marketing & Recruitment Strategies"

Under the guidance of

Mr. Hunny

Project duration
10 Oct, 2022 to 25 Nov, 2022

The internship assessment fulfils the stated criteria and student findings are her original work.

We hereby certify her work satisfactory to the best of my knowledge with an aggregate
Grade C

Location for internship-
Delhi - NCR / Work from Home

We wish her all the best for future endeavours.

Warm Regards



(Authorized Signatory)
HUMAN RESOURCE
Zielhoch



Percept Infocore - Consultants

Outstanding Performance Certificate

is awarded to

Ms. MANGI . R. KHORRAGADE

In recognition of outstanding performance for

HUMAN RESOURCE TRAINING

ON NOVEMBER, 2022

Percept Infocore

Authorised Signatory

Mr. Partha Biswas
Franchise Owner

CERTIFICATE OF COMPLETION

Date: 16 Dec, 2022

This certificate is awarded to

Ms. Nikita Meshram

in appreciation for her successful work as an intern in Zielhoch Company.

she has completed her Summer Internship with project title

"Marketing And Financial Strategies"

Under the guidance of

Mr. Harshit Agarwal

Project duration
10 Oct, 2022 to 25 Nov, 2022

The internship assessment fulfils the stated criteria and student findings are her original work.

We hereby certify her work satisfactory to the best of my knowledge with an aggregate
Grade C

Location for internship-
Delhi - NCR / Work from Home

We wish her all the best for future endeavours.

Warm Regards



(Authorized Signatory)
HUMAN RESOURCE
Zielhoch

CAP & CO

Chartered Accountants

4th Floor, Bhiwapurkar Chambers, Dhantoli, Nagpur -440 012

CERTIFICATE

We hereby certify that
Ms. Priyanka Nandkishor Nikam

A student of M.B.A. at
S. B. Jain Institute of management technology and research, Nagpur

Has successfully completed her Summer Internship Program 2022
Tiled

"TO VERIFY CUSTOMER DOCUMENTS, CREATE
ROC/ITR/GST ACCOUNTING FOR CLIENT'S"
In

CAP & COMPANY
Chartered Accountant
From 01.09.2022 to 15.10.2022

The student has submitted the Final Report and has completed the evaluation
Process.

CA MOHIT BAJAJ

Bajaj

(Director)



CA Mohit M. Bajaj
+91 8275823895

Date: December 20, 2022.

TO WHOMSOEVER IT MAY CONCERN

This is to certify Mr. Vaishno Jitendra Tarhate a student of S. B. Jain Institute of Technology, Management and Research Nagpur, has successfully completed his training on "Sourcing & Procurement Management" in Udaan - Hiveloop Technology Private Limited as a part of curriculum of his MBA for the period 18th Oct to 19th December 2022.

During his training we found him sincere and hardworking.

We wish him all the best for his future assignment.

For & on behalf of Hiveloop Technology Private Limited - Udaan

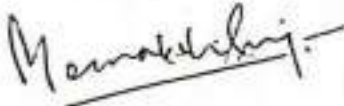

Authorized Signatory

Registered office
Hiveloop Technology Private Limited
#1090G, 18th Cross, 14th Main, Sector 3,
HSR Layout, Bangalore - 560102

CERTIFICATE OF COMPLETION

Date: 16 Dec, 2022

This certificate is awarded to

Mr. Sanket Thakre

in appreciation for his successful work as an intern in Zielhoch Company.

he has completed his Summer Internship with project title

"Marketing And Financial Strategies"

Under the guidance of

Mr. Harshit Agarwal

Project duration
10 Oct, 2022 to 25 Nov, 2022

The internship assessment fulfils the stated criteria and student findings are his original work.

We hereby certify his work satisfactory to the best of my knowledge with an aggregate
Grade C

Location for internship-
Delhi - NCR / Work from Home

We wish him all the best for future endeavours.

Warm Regards



(Authorized Signatory)
HUMAN RESOURCE
Zielhoch



Tue, Dec 17th 2022

SUB : INTERNSHIP COMPLETION LETTER

We are glad to inform you that **Mr. Saurabh Bhotmange** from **S. B. Jain Institute of Technology, Management and Research** has successfully complete his internship at **Vodafone Idea Ltd., Nagpur** from **1st Nov 2022 – 15th Dec 2022**.

During this internship, he was exposed inquisitive and hard working. He was very much interested to learn the functions of our core division and also pulling to put his best efforts and get into the depth of subject to understand it better.

His association with us was very fruitful and wishes him all the best in his future endeavour.

For Vodafone Idea Limited

Misha Rai

Misha Rai

Vice President - Cluster HR Head

myvi.in

Vodafone Idea Limited (Formerly Idea Cellular Limited)
An Aditya Birla Group & Vodafone Partnership
Skyline Icon, 1-3 Floor, Andheri Kurla Road, Morai Naka,
Andheri (East), Mumbai-400 053

Registered Office:
Sunan Tower, Sector 11,
Gandhi Nagar - 382010, Gujarat.
T: +91 79607 34000 | F: +91 79 23232258
CIN: L32100GJ1998PLC000978



Atom O'Sphere

43, Korval Nagar, Ganesh Jyoti, Ring Road,
Nagpur-440022
+91-77091 70976 | team@atomosphere.in

INTERNSHIP LETTER

This is to certify that **Vivek Bhalsare** has successfully completed his internship program at **Atom O'Sphere** as a sales assistant. He has served in our organization from October 04, 2022 to December 09, 2022. At the time of internship he was working on OOH Media.

During the period of internship he worked sincerely on his assignments.

We wish him all the best for upcoming career and future endeavors.

Sincerely,
Abhijeet Daigavane
CEO, Atom O'Sphere

This is a system generated document and it does not require any further endorsements. In case of any concerns reach out to team@atomosphere.in

Date: December 20th 2022

CERTIFICATE OF SUMMER INTERNSHIP

We hereby certify that Mr. Pranay Rajendra Patil 3rd Semester Student of MBA from S.B. JAIN INSTITUTE OF TECHNOLOGY MANAGEMENT AND RESEARCH, NAGPUR, has undergone his summer Internship Program as Part of his curriculum during the period w.e.f. Oct 1st, 2022 to Nov 15th, 2022. He has done a project in "A Study On Financial Performance Of The Ultraquery Technologies India Private Limited Through Ratio Analysis" in our Finance Department.

During his tenure with us we found him as Sincere, Hardworking and having necessary skill related to his profession. He is also having active habits and pleasing manners.

We wish him all success in his future endeavors.

Sincerely,



Suraj Kumar
Director

ULTRAQUERY TECHNOLOGIES INDIA PRIVATE LIMITED.

ULTRAQUERY TECHNOLOGIES INDIA PRIVATE LIMITED

01, Plot No.73, CDC Dreamland, Purnanagar, Pune-411019

Tel: +91 8087151660

info@ultraquery.com | hr@ultraquery.com | www.ultraquery.com

CERTIFICATE OF COMPLETION

Date: 23 Jan, 2023

This certificate is awarded to

Mr. Siddhant Modkar

in appreciation for his successful work as an intern in Zielhoch Company.

he has completed his Summer Internship with project title

"Marketing & Recruitment Strategies"

Under the guidance of

Mr. Harshit Sharma

Project duration
10 Oct, 2022 to 10 Dec, 2022

The internship assessment fulfils the stated criteria and student findings are his original work.

We hereby certify his work satisfactory to the best of my knowledge with an aggregate
Grade B

Location for internship-
Delhi - NCR / Work from Home

We wish him all the best for future endeavours.

Warm Regards



(Authorized Signatory)
HUMAN RESOURCE
Zielhoch



Western Coalfields Limited,
Office of the Area General Manager,
Nagpur Area,
P.O. Jaripatka, Nagpur-440014.

यकोल/क्षेत्र/नाम/ प्रशासन/22/679

दिनांक - 24.11.2022

CERTIFICATE

This is certified that Ku Nikita Ashok Khobragade, student of MBA from S B Jain Institute of Technology & Management has undergone with the Internship Training for the period 10.10.2022 to 23.11.2022 in the office of AGM, Nagpur Area, Western Coalfields Limited (A Subsidiary of Coal India Ltd.) .

During the period of learning, we observed her sincere attitude towards gaining knowledge.

This certificate is being issued for completion of her training session .

उप क्षेत्राधीन
नागपुर क्षेत्र 24/11/2022

प्रतिलिपी -
क्षेत्रीय प्रशिक्षण अधिकारी, नागपुर क्षेत्र

THERMAX LIMITED THERMAX HOUSE, 14 MUMBAI PUNE ROAD, WAKDEWADI,
PUNE 411 002, INDIA | TEL. (INTL) 91 20 25542122 | FAX. (INTL) 25541226
Website: www.thermaxgroup.com | PAN - AAAC13910EJ
Customer Care: 18002000115 (India Toll Free)

Human Resources Division



Date: 06-02-2023

TO WHOMSOEVER IT MAY CONCERN

This is to certify that **Mr. Shabaz shelkh**, is associated with us as an intern in the **Human Resource - L & D** division from 20 November 2022 to 4 February 2023. He is managing his project **efficiently**. The projects are into assisting the calendar engagement and **Dashboard reports** under guidance of Ms. Rukhsana Shaikh.

He is very sincere and Hardworking and focused person.

For Thermax Limited

MeenalRao

Group Head HR, Corporate HR, ER, Admin

HUMAN RESOURCES
THERMAX LIMITED
14 MUMBAI-PUNE ROAD,
SHIVAJINAGAR, PUNE-5.



Sairam Builders & Developers

INTERNSHIP CERTIFICATE

January 13, 2023



This certification proves that Mr. Suraj Bute has completed the internship program at Sai Ram Builders & Developers as a Sales Associate. Suraj Bute started joining the program from 2/12/2022 until 3/01/2023.

During his stay in the company as an Intern, he displays enthusiasm, leadership, self-discipline, and self-motivation.

We are lucky to have him as one of our interns before and we would like to wish him all the best.

Sincerely,

Co Founder

For SHREE SAI DEVELOPERS

Nitin Gedam PARTNER

Sairam Builders & Developers

SAIRAM
Builders & Developers

13-1-23

Contact - 7972147712

Address - Near Nagar Parishad Kalmeshwar, Block No. 7 Katol Road , Kalmeshwar
41501

Date: December 20, 2022.

TO WHOMSOEVER IT MAY CONCERN

This is to certify Mr. Akshay Chandrakant Shiware a student of S. B. Jain Institute of Technology, Management and Research Nagpur, has successfully completed his training on "Sourcing & Procurement Management" in Udaan - Hiveloop Technology Private Limited as a part of curriculum of his MBA for the period 18th Oct to 19th December 2022.

During his training we found him sincere and hardworking.

We wish him all the best for his future assignment.

For & on behalf of Hiveloop Technology Private Limited - Udaan

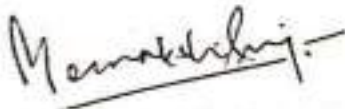

Authorized Signatory

Registered office
Hiveloop Technology Private Limited
#1090G, 18th Cross, 14th Main, Sector 3,
HSR Layout, Bangalore - 560102

CERTIFICATE OF COMPLETION

Date: 13 Dec, 2022

This certificate is awarded to

Ms. Priyanka Eknath Chouhan

In appreciation for her successful work as an intern in Zielhoch Company.

she has completed her Summer Internship with project title

"Marketing And Financial Strategies"

Under the guidance of

Mr. Harshit Sharma

Project duration
10 Oct, 2022 to 10 Dec, 2022

The internship assessment fulfils the stated criteria and student findings are her original work.

We hereby certify her work satisfactory to the best of my knowledge with an aggregate
Grade C

Location for internship-
Delhi - NCR / Work from Home

We wish her all the best for future endeavours.

Warm Regards



(Authorized Signatory)
HUMAN RESOURCE
Zielhoch

GANESH MORESHWAR TIGHARE
CHARTERED ACCOUNTANT
Pachare complex, near matoshri high school, Tukum, Chandrapur-442401

TO WHOM SO EVER MAY CONCERN

This is to certify that Prajwal Ganpati Murodiye student of S.B.Jain Institute of Technology, Management and Research, Nagpur has completed his training in Direct and Indirect Taxation at Ganesh Moreshwar Tighare

He has completed 45 days training from 25-10-2022 to 08-12-2022 in our organization During this period he successfully completed the internship assigned to him. He has been Sincere, Hardworking and punctual in his internship tenure.

CHANDRAPUR

DATE 08-12-2022

CA GANESH MORESHWAR TIGHARE

CHARTERED ACCOUNTANTS

M.NO 179772

Ganesh





CA Mahesh Mandhania
(Partner)

Contact No: 9422903704
E-Mail: maheshmandhania123@gmail.com

DAVA & ASSOCIATES
Chartered Accountants

Office: Flat no.4C, 4th Floor, Gurushankar
Apartment, Plot no.4A, Tilak Nagar,
Amravati Road, Nagpur-440010(M.H.)

To,

Head of department –MBA

S.B. Institute of Technology, Management & Research,
Nagpur.

Subject: INTERSHIP CERTIFICATE

Reference: You're Letter No. SBJITMR/DoM/ 2022-23/IP/03 dated 26/09/2022.

Dear Sir,

With reference to your aforesaid letter, we would like to inform you that Ms. Kirti Anup Panpalia resident of Nagpur has completed internship of 60 days with us.

She has learned basics of Accountancy, Audit, GST, and Income Tax and finance part form other clerical work.

We Extend Our Best Wishes For Her Future.

FOR DAVA & ASSOCIATES
CHARTERED ACCOUNTANTS

F.R.N. 114157



(CA MAHESH MANDHANIYA)

PARTNER

M. NO. 114945

PLACE: NAGPUR

DATED: 1STTH November 2022

GAWANDE ENTERPRISES

Mob. No. 9049700880
9158979685

Building Material Supplier

Godown : Plot No. 3, Ubali Road, Ghorad, Kalmeshwar.

To,

Date :

CERTIFICATE

This is to certify that Mr. Pratik D. Gawande had been working with us under "Summer Internship Programme (2022-23)" for the period from Sept-22 to Nov-22.

During this period, he was looking after Daily Sales and Dispatches, Accounting and Banking activities.

During his internship, he was very disciplined and had good moral conduct.

For GAWANDE ENTERPRISES



PROPIETOR

CERTIFICATE OF COMPLETION

Date: 24 Jan, 2023

This certificate is awarded to

Ms. Amisha Kolhe

in appreciation for her successful work as an intern in Zielhoch Company.

she has completed her Summer Internship with project title

"Marketing & Financial Strategies"

Under the guidance of

Mr. Hunny

Project duration
10 Oct, 2022 to 25 Nov, 2022

The internship assessment fulfils the stated criteria and student findings are her original work.

We hereby certify her work satisfactory to the best of my knowledge with an aggregate
Grade C

Location for internship-
Delhi - NCR / Work from Home

We wish her all the best for future endeavours.

Warm Regards



(Authorized Signatory)
HUMAN RESOURCE
Zielhoch



SAIRAM Builders & Developers

INTERNSHIP CERTIFICATE

January 13, 2023



This certification proves that Mr.Maitrey Tembhumikar has completed the internship program at Sai Ram Builders & Developers as a Sales Associate. Maitrey Tembhumikar started joining the program from 2/12/2022 until 3/01/2023.

During his stay in the company as an Intern, he displays enthusiasm, leadership, self-discipline, and self-motivation.

We are lucky to have him as one of our interns before and we would like to wish him all the best.



Sincerely,
Co Founder
For SHREE SAI DEVELOPERS

Nitin-Gedam **PARTNER**

Sairam Builders & Developers

13-1-2023

Contact - 7972147712
Address - Near Nagar Parishad Kalmeshwar, Block No. 7 Katol Road , Kalmeshwar
441501

HCL TECHNOLOGIES LTD.

Corporate Identity Number: L7414032L1991PL2048368

Technology Hub, Special Economic Zone

Plot No: 5A, Sector 126, NOIDA 201 304, UP, India

T: +91 120 6125000 F: +91 120 4683330

Registered Office: 808, Sakdharin, 96, Nehru Place, New Delhi-110219, India

www.hcltech.com

www.hcl.com

October 10, 2022 Suchi

Bhupendra Rahangdale
Flat no 104 Royal homes, Sarode nagar Chandmari ro
Wathoda layout, Nagpur
Maharashtra
India

Sub: Internship with HCL Technologies Limited

Dear Suchi Bhupendra Rahangdale ,

Congratulations!

This is in response to your application for internship dated **October 10, 2022**.

We are pleased to offer you an internship in **HCL Technologies Limited** ("HCL" or "Company").

We take this opportunity to thank & appreciate your decision to join HCL. You are requested to join us on or before **October 12, 2022**.

The internship shall be governed by the terms and conditions as laid down hereunder in this internship agreement as stated in **ANNEXURE 1**.

We extend a warm welcome to you as an 'intern' in our establishment.

For HCL Technologies Limited,

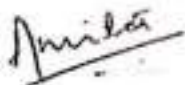

Amrita Das
Senior Vice President
Head-Global Rewards

1

Signature of Employee:

HCL

HCL TECHNOLOGIES LTD

Corporate Identity Number: L28240DL1991PLE066388
Technology Hub, Special Economic Zone
Plot No: 3A, Sector 120, NOIDA 201 304, UP, India.
T: +91 120 8125000 F: +91 120 4680030
Registered Office: 826, Sudharta, 66, Nehru Place, New Delhi 110019, India
www.hcltech.com
www.hcl.com

October 10, 2022 Kale Priti

Ramesh
Plot No.75, Daga Layout North
Ambazari Road, Nagpur,
Maharashtra
India

Sub: Internship with HCL Technologies Limited

Dear Kale Priti Ramesh ,

Congratulations!

This is in response to your application for internship dated **October 10, 2022**.

We are pleased to offer you an internship in **HCL Technologies Limited** ("HCL" or "Company").

We take this opportunity to thank & appreciate your decision to join HCL. You are requested to join us on or before **October 12, 2022**.

The internship shall be governed by the terms and conditions as laid down hereunder in this internship agreement as stated in **ANNEXURE 1**.

We extend a warm welcome to you as an 'intern' in our establishment.

For HCL Technologies Limited,

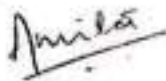

Amrita Das
Senior Vice President
Head-Global Rewards

1

Signature of Employee:

HCL



SAIRAM Builders & Developers

INTERNSHIP CERTIFICATE

January 13, 2023



This certification proves that Mr. Vaibhav Thakre has completed the internship program at Sai Ram Builders & Developers as a Sales Associate.

Vaibhav Thakre started joining the program from 2/12/2022 until 3/01/2023.

During his stay in the company as an Intern, he displays enthusiasm, leadership, self-discipline, and self-motivation.

We are lucky to have him as one of our interns before and we would like to wish him all the best.

Sincerely,

Co Founder

Nitin Gedam

Sairam Builders & Developers

13-1-23

Contact - 7972147712

Address - Near Nagar Parishad Kalmeshwar, Block No. 7 Katol Road , Kalmeshwar 441501

HCL TECHNOLOGIES LTD.
Corporate Identity Number: L74140DL1991PLED06309
Technology Hub, Special Economic Zone
Plot No: 3A, Sector: 126, MIDC 201 204, IIT, India.
T +91 120 4121000 F +91 120 4003030
Registered Office: 804 Siddharth, 88, Nerva Place, New Delhi-110016, India.
www.hcltech.com
www.hcl.com

October 10, 2022 PATKI

SWARALI RAJESH
s- Plot no. 2, Naik Nagar ,
Manewada Road, Nagpur,
Maharashtra
India

Sub: Internship with HCL Technologies Limited

Dear PATKI SWARALI RAJESH ,

Congratulations!

This is in response to your application for internship dated October 10, 2022.

We are pleased to offer you an internship in HCL Technologies Limited ["HCL" or "Company"].

We take this opportunity to thank & appreciate your decision to join HCL. You are requested to join us on or before October 12, 2022 .

The internship shall be governed by the terms and conditions as laid down hereunder in this internship agreement as stated in ANNEXURE 1.

We extend a warm welcome to you as an 'intern' in our establishment.

For HCL Technologies Limited,

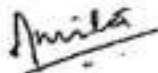

Anurita Das
Senior Vice President
Head-Global Rewards

1

Signature of Employee:

HCL

CHIKHALIKAR SAPRA & COMPANY
CHARTERED ACCOUNTANTS



Office :
Circuit House Road,
Near Mahavir Jewellers,
JAGDALPUR (Bastar) C.G.
☎(LL) : 07782-357375
Mob. No. : 86027 30706

PRATIK CHIKHALIKAR F.C.A.

Email id : capratik@gmail.com

TO WHOMSOEVER IT MAY CONCERN

THIS IS TO CERTIFY THAT MS. SANKETI SABLE, WHO WAS PURSUING HER MASTER OF BUSINESS ADMINISTRATOR DEGREE IN FINANCIAL MANAGEMENT FROM S.B. JAIN INSTITUTE OF MANAGEMENT AND RESEARCH COLLEE, NAGPUR. HAS SUCCESSFULLY COMPLETED HER SUMMER INTERNSHIP AT OUR JAGDALPUR BRANCH FROM 01-10-2022 TO 30-11-2022 IN PARTIAL FULFILLMENT OF THE AWARD OF POST GRADUATE DEGREE IN BUSINESS ADMINISTRATION WAS FOUND TO BE GOOD.

WE WISH HER EVERY SUCCESS IN LIFE.

*For Chikhalikar Sapra and Company,
Chartered Accountants,*



(Pratik Chikhalikar)

Partner

*M. NO.421486
F.R.N 029112C*

Place : Jagdalpur

Date : 08.12.2022



Bennett, Coleman & Co. Ltd
Nagpur Office: The Times of India Building, Rama House, 111 & 2, 08,
East High Court Road, Handwade, Nagpur - 440010. T 0712-3541222.
E-mail: nagpur@bco.com
Registered Office: The Times of India Building, Dr. D.N. Road, Mumbai 440001, INDIA
Corporate Identity No. U22120MH11913PLC000301

Date: - 17th Oct 2022

To

Ms. Bharti Sudhakar Ukey

Roll No. MB21017

S. B. Jain Institute of Technology, Management and Research, Nagpur

We are pleased to inform you that you have been selected for the BCCL- Access internship program for the period 10th Oct 2022 – 23rd Nov 2022. You will be undergoing the program with the Research & Market development team at Nagpur.

For the internship program, you would be working specifically on projects related to readership engagement, readership enhancement across various segments like individual households, OOHs, offices etc.

Wishing you all the best for a successful & rewarding internship.

Regards

Abhinandhi
Dy. Chief Manager
Research & Market Development
BCCL.

The Times of India The Economic Times Mumbai Mirror Business Standard Speaking Tree Times
New NavBharat Times Nav Gujarat Samay Maharashtra Times Et Samay Vjy Karnataka
Lokmat Fernis Haha Keralabharati ET NOW Zoom Femina Hiss Movies Now Indiatimes
Iqbalbricks Timesjoba Gaana



To,
Head of Department – MBA
S.B.Jain Institute of Technology, Management & Research,
Nagpur.

Subject : INTERNSHIP CERTIFICATE

Reference : Your Letter No. SBJITMR/DoM/2022-23/IP/03 dated 26/09/2022.

Dear Sir,

With reference to your aforesaid letter, we would like to inform you that Ms. Arya Sanjay Kayarkar resident of Nagpur has completed internship of 60 days with us.

She has learned basics of Accountancy, Audit, GST, Income Tax apart from other clerical work.

We extend our best wishes for her future.

NAGPUR



DATED : 28th November, 2022

For L N J & ASSOCIATES
Chartered Accountants
F.R.N. 135772W

Nilesh Veged

(NILESH VEGED)
Partner
M. No. 144961



RALLIS INDIA LIMITED

A TATA Enterprise

CERTIFICATE OF INTERNSHIP

THIS CERTIFICATE IS AWARDED TO

MR. VISHAL GANESHRAO KUHITE

A student of ***S. B. Jain Institute of Technology, Management and Research Nagpur*** has successfully completed the internship program starting from 5th October 2022 to 5th December 2022. During the period of internship he had been exposed to different process and was found diligent, hardworking and inquisitive

We Wish Him All Success In Him Life

SWAPNIL CHATTKI

A.S.M

SIDDHESH SANGAR

T.M



KND & ASSOCIATES

Chartered Accountants

INTERNSHIP COMPLETION LETTER

THIS IS TO CERTIFY THAT, Miss. Lata Wararkar D/o Shankarrao Wararkar, student of S.B. Jain Institute of Technology, Management & Research, Nagpur has successfully completed her Internship in our firm at Nagpur from October 2022 to November 2022.

During her Internship, she was acquainted to various activities in the field of audit, accounts & finance.

We found her hardworking & her association with us was beneficial to our organization.

Place: Nagpur

**For KND & ASSOCIATES
Chartered Accountants**



Date: 01/12/2022

Suren Duragkar
**Suren Duragkar
(Partner)
Mem.No.044926**



Atom O'Sphere Cloud Technologies Pvt. Ltd

43, Kotwal Nagar, Ganesh Jyoti, Ring Road,

CIN: U72900MH2021PTC360518

Nagpur-440022

+91-77091 70976 | team@atomosphere.in



INTERNSHIP CERTIFICATE

This is to certify that **Shubham N. Dhanvijay** has successfully completed his internship program with **Atom O'Sphere Cloud Technologies Pvt. Ltd.** At the time of internship he was working with the management department in the organization as a coordinator. He has served in our organization from October 06, 2022 to December 07, 2022. Under the guidance of Mr. Ravindra Yadav (CTO) and Ms. Kasturi Bapat (Project Manager).

We have him to be a self starter who is motivated and Hard-Working. He worked sincerely on his assignments and his performance was excellent.

We wish him all success in future endeavors.

Sincerely,
Atom O'Sphere Cloud Technologies Private Limited,

Abhijeet Daigavane
Director

In case of any concerns reach out to team@atomosphere.in

www.atomosphere.in

INTERNSHIP COMPLETION LETTER

THIS IS TO CERTIFY THAT, Miss. Renuka Randive D/o Vasantryo Randive, student of S.B. Jain Institute of Technology, Management & Research, Nagpur has successfully completed her Internship in our firm at Nagpur from October 2022 to November 2022.

During her Internship, she was acquainted to various activities in the field of audit, accounts & finance.

We found her hardworking & her association with us was beneficial to our organization.

Place: Nagpur

For KND & ASSOCIATES
Chartered Accountants



Date: 01/12/2022

Suren Duragkar
Suren Duragkar
(Partner)

Mem.No.044926

THE TIMES OF INDIA

ACCESS

Student's Window to the Corporate World

This is to certify that

Miss. Muskan Mahendra Pendor of S.B Jain Institute of Technology, Management & Research, Nagpur, has successfully completed the Times Access internship program of 2022-23.

Her performance during the program is adjudged as excellent.



Reporting Manager

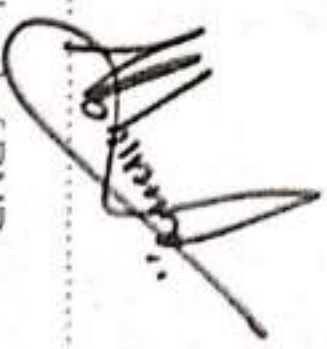

Head of RMD,
The Times of India



To,
Head of Department – MBA
S.B.Jain Institute of Technology, Management & Research,
Nagpur.

Subject : INTERNSHIP CERTIFICATE

Reference : Your Letter No. SBJITMR/DoM/2022-23/IP/03 dated 26/09/2022.

Dear Sir,

With reference to your aforesaid letter, we would like to inform you that Ms. Reena Kishor Paunikar resident of Nagpur has completed internship of 60 days with us.

She has learned basics of Accountancy, Audit, GST, Income Tax apart from other clerical work.

We extend our best wishes for her future.

NAGPUR



For L N J & ASSOCIATES
Chartered Accountants
F.R.N. 135772W

Nilesh Veged

(NILESH VEGED)
Partner
M. No. 144961

DATED : 28th November, 2022

SWASTIK PACKERS

23, Gandhi Grain Market, Central Avenue,
Near Telephone Exchange Square,
Nagpur-440008

"SUMMER INTERNSHIP CERTIFICATE"

This is to certify that Ms. Jyoti Rajnish Dubey, a student of MBA in Finance and HR at S.B Jain Institute of Management, has successfully completed 45 Days (Form 03th Oct, 2022 To 18th Nov 2022) Internship Programme.

During the period of her internship program with us, she was found punctual, hardworking and inquisitive.

We wish her every success in life.



Abhinandan Jejani
(Owner)

Swastik Packers

03760006, 771902
SWASTIK PACKERS
23, Gandhi Grain Market, Central Avenue,
Near Telephone Exchange Square, Nagpur-440 008

THE TIMES OF INDIA

ACCESS

Student's Window to the Corporate World

This is to certify that

Mr. Suraj Sheshraoji Bhusari of S.B Jain Institute of Technology, Management & Research, Nagpur, has successfully completed the Times Access internship program of 2022-23.

Her performance during the program is adjudged as excellent.



Reporting Manager

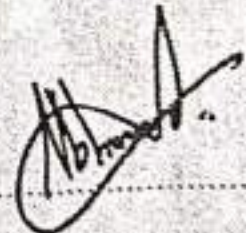

Head of RMD,
The Times of India

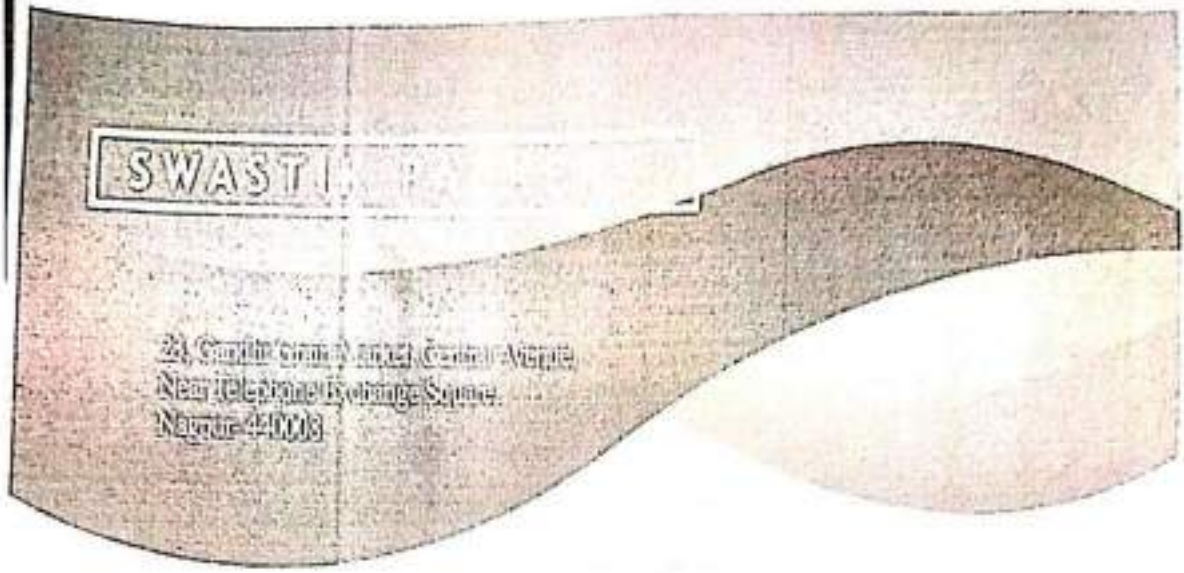

"SUMMER INTERNSHIP CERTIFICATE"

This is to certify that Ms. Vaishnavi Vinod Chhatre, a student of MBA in Finance and HR at S.B Jain Institute of Management, has successfully completed 45 Days (From 03rd Oct, 2022 To 18th Nov 2022) Internship Programme.

During the period of her internship program with us, she was found punctual, hardworking and inquisitive.

We wish her every success in life.

91 750036 771682
SWASTIK PACKERS

Anand Jeant
(Owner)
Swastik Packers



गांधीबाग सहकारी बँक लि., नागपूर.

मुख्य कार्यालय : चित्रीस पार्क चौक, रुकुम मार्ग, महाल, नागपूर - ४४००३२, फोन नं. २७२२२७६, २७२२२८४, २७२२५८५

Gandhibagh Sahakari Bank Ltd., Nagpur

Head Office : Chitris Park Chowk, Rukar Marg, Mahal, Nagpur - 440032, Ph.: 2722276, 2722284, 2722585

Branches • Main Branch: Chitris Park Mahal, Nagpur Ph: 2722274 • Market Chowk, Itanar, Nagpur Ph: 2761561 • Hingna Road, MDC, Nagpur Ph: 07104-237967
• Athegaon, Mukteshwar Road, Nagpur Ph: 2746636 • Manewadi, Besa Road, Nagpur Ph: 2746638 • Ehandara, Park, Nagpur
• Near Athav Taluk, Chandrapur Ph: 0712-254147 • e-mail: gsbho@gandhibagbank.com Website: www.gandhibagbank.com

दि. नं. ६३५/२०२२-२५

Date: 05/12/2022

C E R T I F I C A T E

This is to certify that Ms. Neha Vishweshwar Randive a student from S. B. Jain Institute of Technology, Management & Research, Nagpur. M.B.A 1st Semester has completed summer internship project training in this bank satisfactorily for the period from 28/10/2022 to 28/11/2022 total 30 days as required under the M.B.A. course. During the period under training, she is found to be a sincere and hardworker bearing a good moral character besides displaying a sense of belongingness in the work allotted to her.

We wish her bright future and all success in her future endeavour.

(B. P. VHANAWARE)
Chief Executive Officer

Corporate Office : Plot No. 20, MIDC Industrial Area, Kalmeshwar,
Dist. Nagpur-441 501, (M.S.) India
Ph: 07110-271010, 271000 Fax: 07110-272522
E-mail: corporate@unijules.com

Work At : Survey No. 330 (P-30), Next to MIDC Industrial Area,
Kalmeshwar Dist. Nagpur-441501, (M.S.) India
Ph: 07110-272244 Fax: 07110-272522
E-mail: herbal@unijules.com
Mfg. Lic No. NG/WYU/004/11
GST No. 27AAACU8032012K



www.unijules.com
UNIJULES
LIFE SCIENCES LTD.
"From Farm to Pharma"
WHO GMP & ISO 9001:2015 Certified Company

SUMMER INTERNSHIP CERTIFICATE

This is to certify that Mr. Pratik Vitthal Mahakalkar, a student of MBA in Human Resource and Marketing at S.B Jain Institute of Management, has successfully completed 45 days (from 03rd Oct, 2022 To 18th Nov 2022) Internship and Programme.

During the period of his internship program with us, he was found punctual, hardworking and inquisitive.

We wish him every success in life.

Israel Sheikh
(Plant Manager)



Unijules Life Sciences Ltd.

VIDARBHA FINANCIAL SERVICES

Office Address : Orange Plaza, B Wing Katol Dist : Nagpur

E-mail: sachin9-1979@gmail.com

Date: 15/12/2022

TO WHOM IT MAY CONCERN

This is to certify Full Name MS. MRUNAL NARENDRA REWATKAR a student of MBA, SB JAIN INSTITUTE OF TECHNOLOGY MANAGEMENT AND RESEARCH, NAGPUR has successfully completed 45 day (From 29th October to 11th December 2022) long summer internship program at this Company.

During the period of his internship program with us. She was found Punctual hardworking and inquisitive.

We wish him every success in life

Authorized Signature



SUIDHA FOUNDATION

Serving the Society Since 20+ Years

04/11/2022

CERTIFICATE OF DONATION

This certificate is proudly presented to:

Nandini Gajanan Dhurve

for contributing **Rs 200** towards making our organization a smashing success.
Only with committed persons like you we can organize and run events.

Bharti

MRS. BHARTI SHENDRE
Treasurer

Shobha Motghare

MRS. SHOBHA MOTGHARE
Secretary



SUIDHA FOUNDATION

Serving the Society Since 20+ Years
Suidha Mahila Mandal

SMM222320327

Certificate of Completion

This certificate is presented to

Ms. Nandini Gajanan Dhurve

In recognition of completion of internship in Fundraising Coordinator
from 11 Oct 2022 to 11 Nov 2022 at Suidha Foundation. During the period
of his/her internship programme with us, he/she was found punctual and inquisitive.
We wish him/her all the best for his/her future endeavours.



In collaboration with

Shobha Motghare

Mrs. Shobha Motghare
Secretary

THE TIMES OF INDIA



ACCESS

Student's Window to the Corporate World

This is to certify that

Ms. Sakshi Kishor Shende of S.B. Jain Institute of Technology, Management & Research, Nagpur, has successfully completed the Times Access internship program of 2022-23.

Her performance during the program is adjudged as excellent.

A handwritten signature in black ink, appearing to read 'Rajiv', written over a horizontal dotted line.

Reporting Manager

A handwritten signature in black ink, appearing to read 'A. Chandra', written over a horizontal dotted line.

Head of RMD,
The Times of India



CERTIFICATE OF COMPLETION

Date: 02 Jan, 2023

This certificate is awarded to **Mr. Vinay Sahani** In appreciation for his successful work as an intern in Cluematrix Technologies. He completed Summer Internship in **"HR RECRUITMENT AND SELECTION"** Under the guidance of **Mr. Abhijeet Kamdi** Internship duration 10 Oct, 2022 to 10 Dec, 2022.

The internship assessment fulfils the stated criteria and student findings are his original work.

We hereby certify his work satisfactory to the best of my knowledge with an aggregate **Grade A.**

Location for internship-
Nagpur / Work from Home

Sincerely,

Cluematrix Technologies Pvt. Ltd.

A handwritten signature in black ink, appearing to read "Hemant Barapatre", is written over a horizontal line.

Director

Hemant Barapatre

Director, Cluematrix Technologies Pvt. Ltd.

Cluematrix Technologies Pvt. Ltd. (Previously Known as Cluebix Software Pvt. Ltd.)

CIN: U74999MH2016PTC281886

Web: www.clueermatrix.com/ | Mob No: 9552743409 |E.mail: supportinfo@clueermatrix.com

SWASTIK PACKERS

23, Gandhi Gram Market, Central Avenue,
Near Telephone Exchange Square,
Nagpur-440008.

"SUMMER INTERNSHIP CERTIFICATE"

This is to certify that Ms. Shilpa Gajanan Dhurve, a student of MBA in Finance and HR at S.B Jain Institute of Management, has successfully completed 45 Days (From 03rd Oct, 2022 To 18th Nov 2022) Internship Programme.

During the period of her internship program with us, she was found punctual, hardworking and inquisitive.

We wish her every success in life.

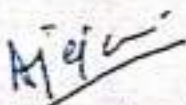
Abhinandan Jejani
(Owner)
Swastik Packers

(01) 760080, 771987
SWASTIK PACKERS
23, Gandhi Gram Market, Central Avenue,
Near Telephone Exchange Square, Nagpur-440



माऊली नवनिर्माण

भारत नवनिर्माण माऊली निधी

MAULI NAVNIRMAN SAKKARDARA NIDHI LIMITED

माऊली नवनिर्माण सक्करदरा निधी लिमिटेड

आपला निधी आपली वृद्धी

CIN NO. - U65999MH2021PLN363215

कार्यालय : क्वार्टर नं. 1/3-731, राजेशपुरी नगर, कमला नेहरू कॉलेज जवळ, नागपूर-440 009.

Email : maulinavnirmansakkardara@gmail.com

Ph.No. : 8652740740

Website : www.maulinavnirmansakkardara.in

“INTERNSHIP CERTIFICATE”

January 25, 2023

TO WHOMSOEVER IT MAY CONCERN

We are glad to inform you that Miss. Neha Sushii Ingoie from S.B. Jain Institute of Technology, Management & Research, Nagpur, has successfully completed her Internship at Mauli Navnirman Sakkardara Nidhi Limited from 13/10/2022 To 10/12/2022.

During her internship, she was exposed to the various activities in Banking Operations. We found her extremely inquisitive and hard working. She was very much interested to learn the functions of banking sector and also willing to put her best efforts to understand it better.

Her association with us was very fruitful and we wish her all the best in her future endeavors.

MANAGER
MAULI NAVNIRMAN
SAKKARDARA NIDHI LTD.

Mr. Prashant B. Warade

Manager

Mauli Navnirman Sakkardara Nidhi Limited



माऊली नवनिर्माण

भारत सरकार मान्यता प्राप्त

MAULI NAVNIRMAN NIDHI LIMITED

माऊली नवनिर्माण निधी लिमिटेड

आपला निधी आपली वृद्धी

CIN : U65929MH2019PLN330620

कार्यालय : प्लॉट नं. ५, शेतीबागे रोड, बालाजी सेलॅब्रेशन हॉम जवळ, बी.एल.एन.एच, ऑर्बिस समोर, सावनेर, नागपूर - पत्रा ४३१११३

Ph. No. 07113-233624 * Email : maulinavnirmanidhi@gmail.com * Website : www.maulinavnirman.in

Ref.No. 232/24/01/2023

Date 24/01/2023

INTERNSHIP CERTIFICATE

This is to certify that name **Miss Dhanshree Bhalerao** a student of MBA 1st Year at S.B. Jain Institute of Technology, Management & Research, Nagpur, has completed the Internship Program from 13/10/2022 to 10/12/2022.

During the period of her Internship Program with us, she was found punctual, hardworking, and inquisitive.

We wish her every success in life.

MANAGER
MAULI NAVNIRMAN
NIDHI LTD.
Manager

THE TIMES OF INDIA

ACCESS

Student's Window to the Corporate World

This is to certify that

Mr. Nikhil Gajendra Thakare of S.B Jain Institute of Technology, Management & Research, Nagpur, has successfully completed the Times Access internship program of 2022-23.

Her performance during the program is adjudged as excellent.



Reporting Manager



Head of RMD,
The Times of India

THE TIMES OF INDIA

ACCESS
Student's Window to the Corporate World

This is to certify that

Ms. Vaishnavi Sanjay Kale of S.B. Jain Institute of Technology, Management & Research, Nagpur, has successfully completed the Times Access internship program of 2022-23.

Her performance during the program is adjudged as excellent.



Reporting Manager



Head of RMD,
The Times of India

CERTIFICATE OF COMPLETION

Date: 07 Jan, 2023

This certificate is awarded to

Ms. Sakshi Manoj Tambe

in appreciation for her successful work as an intern in Zielhoch Company.

she has completed her Summer Internship with project title

"Marketing And Financial Strategies"

Under the guidance of

Mr. Harsh Yadav

Project duration
10 Oct, 2022 to 10 Dec, 2022

The internship assessment fulfils the stated criteria and student findings are her original work.

We hereby certify her work satisfactory to the best of my knowledge with an aggregate
Grade B

Location for internship-
Delhi - NCR / Work from Home

We wish her all the best for future endeavours.

Warm Regards



(Authorized Signatory)
HUMAN RESOURCE
Zielhoch

THE TIMES OF INDIA

ACCESS

Student's Window to the Corporate World

This is to certify that

Ms. Samiksha Madhukar Bhusari of S.B. Jain Institute of Technology, Management & Research, Nagpur, has successfully completed the Times Access internship program of 2022-23.

Her performance during the program is adjudged as excellent.



Reporting Manager



Head of RMD,
The Times of India

CERTIFICATE OF COMPLETION

Date: 29 Dec, 2022

This certificate is awarded to

Ms. Yogita Parshivnikar

in appreciation for her successful work as an intern in Zielhoch Company.

she has completed her Summer Internship with project title

"Marketing And Financial Strategies"

Under the guidance of

Mr. Harsh Yadav

Project duration
10 Oct, 2022 to 10 Dec, 2022

The internship assessment fulfils the stated criteria and student findings are her original work.

We hereby certify her work satisfactory to the best of my knowledge with an aggregate
Grade B

Location for internship-
Delhi - NCR / Work from Home

We wish her all the best for future endeavours.

Warm Regards

(Authorized Signatory)
HUMAN RESOURCE
Zielhoch

THE TIMES OF INDIA



ACCESS

Student's Window to the Corporate World

This is to certify that

Ms. Sakshi Mangesh Raulkar of S.B Jain Institute of Technology, Management & Research, Nagpur, has successfully completed the Times Access internship program of 2022-23.

Her performance during the program is adjudged as excellent.

A handwritten signature in black ink, appearing to read 'S. Raulkar', positioned above a dotted line.

Reporting Manager

A handwritten signature in black ink, positioned above a dotted line.

Head of RMD,
The Times of India

TADAIYA & ASSOCIATES

CHARTERED ACCOUNTANT

Nagpur (MH) -440002

Contact No. 9970561898 Email Id. akshat.tadaiya@gmail.com

Certification Of Completion

TO WHOMSOEVER IT MAY BE CONCERN

Ms. Anjali Ashokkumar Singh

This is to certify that Ms. Anjali A. Singh a student of MBA from S. B. Jain Institute Of Technology, Management & Research, situated at Nagpur, has successfully completed 45 Days of Internship in Finance from 03/10/2022 To 18/10/2022 at TADAIYA & ASSOCIATES in ACCOUNTING, INCOME TAX & GST. During the aforesaid tenure she is found to be regular, sincere and punctual.

She has successfully completed the training and we wish her all the very best for all her future endeavors.

For TADAIYA & ASSOCIATES
Chartered Accountants

A. S. Tadaiya

(CA AKSHAT TADAIYA)

Proprietor

Membership No. 162404

UCN: 1006568

UDIN:- 22162404BEPICIS2942



CERTIFICATE OF COMPLETION

Date: 22 Dec, 2022

This certificate is awarded to

Mr. Nikhil Bhelkar

in appreciation for his successful work as an intern in Zielhoch Company.

he has completed his Summer Internship with project title

"Marketing And Financial Strategies"

Under the guidance of

Mr. Harsh Yadav

Project duration
10 Oct, 2022 to 25 Nov, 2022

The internship assessment fulfils the stated criteria and student findings are his original work.

We hereby certify his work satisfactory to the best of my knowledge with an aggregate
Grade B

Location for internship-
Delhi - NCR / Work from Home

We wish him all the best for future endeavours.

Warm Regards



(Authorized Signatory)
HUMAN RESOURCE
Zielhoch

THE TIMES OF INDIA

ACCESS

Student's Window to the Corporate World

This is to certify that

Ms. Bharti Prakash Raut of S.B Jain Institute of Technology, Management & Research, Nagpur, has successfully completed the Times Access internship program of 2022-23.

Her performance during the program is adjudged as excellent.



Reporting Manager



Head of RMD,
The Times of India



भारत सरकार मान्यता प्राप्त

MAULI NAVNIRMAN NAGPUR NIDHI LIMITED

माऊली नवनिर्माण नागपुर निधी लिमिटेड

आपला निधी आपली वृष्टी

CIN : U65990MH2020PLN340534

कार्यालय : प्लॉट नं. ७२०, C-३, श्री नामदेवराव चौधरी, चौधरी मेडिकल, झंडा चौक, भिंगाबाई टाकळी, नागपुर-४४००३०. (महाराष्ट्र)

फोन नं. : ०७१२-२३०९८०० E-mail : maulinavnirmanagnagnidhi@gmail.com Website : www.maulinavnirmanagnpur.in

“Internship Certificate”

This is to certify that Miss. Tamanna Sahare, a student of MBA 1st Year at S. B. Jain Institute of Technology, Management & Research, Nagpur, has successfully completed Internship Program from 13/10/2022 to 10/12/2022.

During the period of her internship program with us, she was found punctual, hardworking and inquisitive.

We wish her every success in life.

BRANCH MANAGER
MAULI NAVNIRAMAN
NAGPUR NIDHI LIMITED

Mrs. Chandranshu S. Choudhari

Manager

Mauli Navnirman Nagpur Nidhi Ltd.



Percept Infosystem - Consultants

Outstanding Performance Certificate

is awarded to

Ms. SWAPNIE R. PANDEY

In recognition of outstanding performance for

HUMAN RESOURCE TRAINING

ON NOVEMBER, 2022

Percept Consultants

Authorised Signatory

Mr. Partha Biswas
Franchise Owner

Ground Floor, Central Apartment, Near Stop in Hotel, Law College Square, Nagpur-10

HCL TECHNOLOGIES LTD.

Corporate Identity Number: L74140DL1991PLC040369

Technology Hub, Special Economic Zone

Plot No : 3A, Sector 126, NOIDA 201 304, UP, India.

T +91 120 6125000 F +91 120 4683030

Registered Office: 806 Siddharth, 9th, Nehru Place, New Delhi-110019, India.

www.hcltech.com

www.hcl.com

January 9, 2023

KHATI AKANKSHA AJAY

260, Keshav Kirti Apartment, Loksewa Nagar

Behind Mokhare College, Nagpur

Maharashtra

India

Sub: Letter of Contract

Dear KHATI AKANKSHA AJAY,

With reference to our discussion, we are pleased to inform you that you have been selected for contract employment with HCL Technologies Limited as Contract Retainer. The following terms and conditions will apply to you -

1. Your contract shall be from **January 23, 2023** to **January 22, 2024**. The contract can be extended for another specified period with mutual consent. Your engagement stands terminated on expiry of contract period unless it is extended further in written. You will be entitled to statutory benefits as per the respective Acts and as per rules/policies of the company.
2. You shall be paid a consolidated amount of **Rs.20000 per month** towards consideration fee, subject to Income tax deduction at source.
3. You will be required to undertake the necessary joining formalities with the company at the time of starting of your engagement
4. The company will undertake the background verification / validation process in terms of education, previous employment(s), criminal verification, database and web searches, address verification, claims made against achievements in the resumes/CVs etc. with the help of a third party as and when required.
5. You are being engaged for this assignment based on your particulars and information made available by you and in case the said particulars/information is found false or incorrect, your engagement will be deemed cancelled *ab-initio*.
6. Generally, we would advise you not to take any leave during your contract engagement. In case of exigencies of work/sickness, you may take one leave per month. Any leave over and above this, will be treated as Leave without payment.
7. The company shall have the discretion to re designate you according to the company's requirement.